

EVENTOS 03

Gama completa de murais promocionais, balcões e bandeiras, que fornecem uma solução integral para a exposições em evento.

- 108** POP UPS
- 121** POP UP ACCESSORIES
- 125** PROMOTION COUNTERS
- 138** TRADESHOW SOLUTIONS
- 148** TRADESHOW SYSTEMS
- 158** TRADESHOW FURNITURE
- 161** OUTDOOR EVENTS
- 162** FLAG BANNERS
- 168** FLAG BANNER ACCESSORIES
- 172** WALL BANNERS
- 178** REFILLABLE BASE BANNERS
- 183** SIDELINE BANNERS



POP UP DETAILS



TEXTIL POP UP INSTALATION

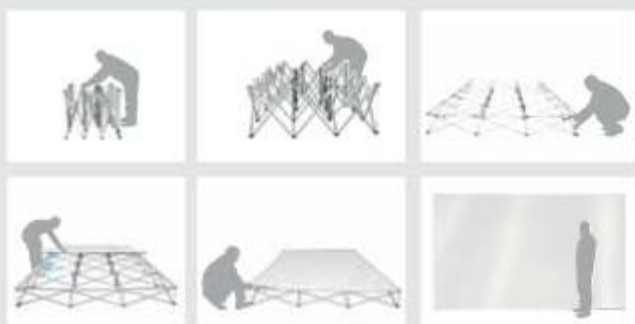

DIMENSIONS

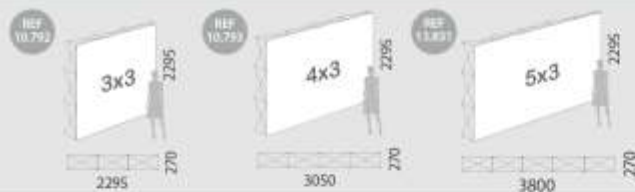

INFORMATION

Ipánema Pop-Up features an aluminium frame with locking arms for an easy assemble. Includes 1 soft-case nylon carry bag and 1 roll of genuine VELCRO® brand fasteners for attachment. This straight fabric Pop-Up is one of the most used options for photocalls. The graphics are simple to attach using the brand fasteners in its perimeter. Ideal for promotional acts, weddings, photocalls or at any stand booth.

IPANEMA 3x3	QTY	N.W	G.W	C.B.M	SIZE
Packing	1	110kg	8.30kg	0,06	855x131x290mm
10.792	3x3 Graphic Size: 2295x2295mm				
IPANEMA 4x3	QTY	N.W	G.W	C.B.M	SIZE
Packing	1	8.65kg	0.36kg	0,06	855x131x290mm
10.793	4x3 Graphic Size: 3050x2295mm				
IPANEMA 5x3	QTY	N.W	G.W	C.B.M	SIZE
Packing	1	11.6kg	11.2kg	0,07	830x220x380mm
13.831	5x3 Graphic Size: 3800x2295mm				

IPANEMA POP UP



* VELCRO® is a registered trademark of Velcro Industries S.L. | VELCRO® is una marca registrada de Velcro Industries S.L. | VELCRO® is a registered trademark of Velcro Industries S.L. | VELCRO® is una marca registrada de Velcro Industries S.L.

POP UP DETAILS



DIMENSIONS ^{mm}

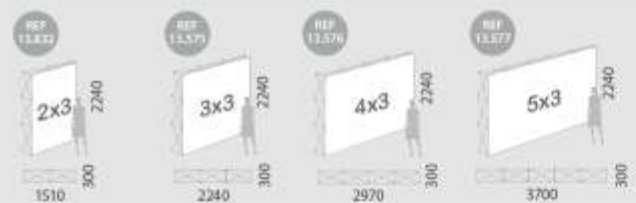

INFORMATION

Surat offers the possibility to fix the graph in the sides of the PopUp (consult the size of the graphics in these cases). Includes 1 soft-case nylon carry bag and 1 roll of genuine VELCRO® brand fasteners for attachment. Surat series feature leveling feet for a suitable adjustment of the PopUp on the surface of the floor.

SURAT 2x3	QTY	N.W	G.W	C.B.M	SIZE
-----------	-----	-----	-----	-------	------

Packing	1	9kg	10kg	0.0347	300x300x830mm
13.832	2x3 Graphic Front: 1510x2240mm Graphic (Front + Sides): 2110x2240mm				

SURAT 3x3	QTY	N.W	G.W	C.B.M	SIZE
-----------	-----	-----	-----	-------	------

Packing	1	9kg	10kg	0.0597	850x260x230mm
13.575	3x3 Graphic Front: 2240x2240mm Graphic (Front + Sides): 2940x2240mm				

SURAT 4x3	QTY	N.W	G.W	C.B.M	SIZE
-----------	-----	-----	-----	-------	------

Packing	1	11kg	12kg	0.0707	850x260x320mm
13.576	4x3 Graphic Front: 2970x2240mm Graphic (Front + Sides): 3670x2240mm				

SURAT 5x3	QTY	N.W	G.W	C.B.M	SIZE
-----------	-----	-----	-----	-------	------

Packing	1	10kg	14kg	0.0714	850x260x350mm
13.577	5x3 Graphic Front: 3700x2240mm Graphic (Front + Sides): 4300x2240mm				

SURAT POP UP



POP UP DETAILS



POP UP DETAILS



DIMENSIONS

*mm



INFORMATION

Cangas Pop-Up is 5 sizes available, featuring an aluminium frame with locking arms for an easy assemble. It includes a trolley Carry Bag and 1 roll of genuine VELCRO® brand fasteners. This straight fabric Pop-Up is one of the most used options for photocalls. The graphics are simple to attach using the brand fasteners in its perimeter. Ideal for promotional acts, weddings, or just for displaying at any stand booth on media events.

CANGAS SIZE	QTY	N.W	G.W	C.B.M	SIZE
Packing	1	13,2kg	15kg	0,2	410x450x950mm

10.413 3x3 Graphic Size: 2295x2295mm

CANGAS SIZE	QTY	N.W	G.W	C.B.M	SIZE
Packing	1	16,39kg	17,95kg	0,2	450x450x950mm

10.414 4x3 Graphic Size: 3050x2295mm

CANGAS POP UP



* Spotlights at the page are optional but not included



* VELCRO® is a registered trademark of Velcro NY&C | VELCRO® are the unique division de Velcro Industries B.V. | VELCRO® is una marca registrada de Velcro Industries B.V. | VELCRO® es una marca registrada de Velcro Industries B.V. | VELCRO® is one brand registered de Velcro Industries B.V.

POP UP DETAILS



Single Sided

POP UP DETAILS



DIMENSIONS *mm

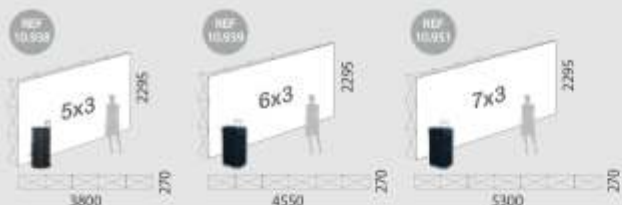

INFORMATION

This straight Textil Pop Up is one of the most used options for photocalls. The model 10.951 is the biggest (2.3x5.3m) Textile Pop Up available. It includes a trolley Carry Bag with wheels and 1 roll of genuine VELCRO® brand fasteners.

CANGAS154	QTY	N.W	G.W	C.B.M	SIZE
Packing	1	10.05kg	11.0kg	0.20	400x400x160mm
10.938	5x3 Graphic Size: 3800x2295mm				

CANGAS164	QTY	N.W	G.W	C.B.M	SIZE
Packing	1	20.50kg	21.9kg	0.20	540x400x160mm
10.939	6x3 Graphic Size: 4550x2295mm				

CANGAS173	QTY	N.W	G.W	C.B.M	SIZE
Packing	1	22.69kg	24.5kg	0.20	540x400x160mm
10.951	7x3 Graphic Size: 5300x2295mm				

CANGAS POP UP



* Lights in the page are available but not included



* VELCRO® is a registered trademark of Velcro Industries S.R.L. | VELCRO® is una marca registrada de Velcro Industries S.R.L. | VELCRO® is a registered trademark of Velcro Industries S.R.L. | VELCRO® is una marca registrada de Velcro Industries S.R.L.

POP UP DETAILS



POP UP INSTALLATION



DIMENSIONS

*mm

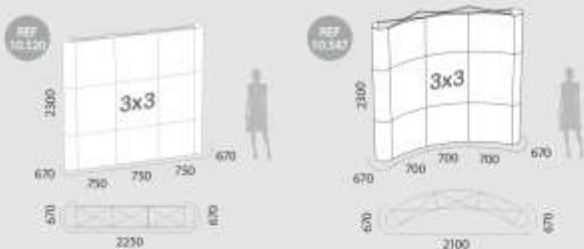

INFORMATION

Laredo 3x3 Pop Up features a straight or curved brushed aluminum frame that is lightweight, yet sturdy. Custom graphics attach to the frame with magnetic loop strips, yet with adhesive to the magnetic strip (1 strip roll is included). Also, 1 nylon trolley carry bag with wheels is included. This portable Pop Up can be set up and taken down in a few minutes. Ideal for enhancing your business's presence at your next media event, exhibition, tradeshow or convention.

3x3 STRAIGHT	QTY	N.W	G.W	C.B.M	SIZE
Packing	1	17.15kg	18.6kg	0.12	390x340x920mm
10.520	Graphic Size:	670x2300mm x2 750x2300mm x3			
3x3 CURVED	QTY	N.W	G.W	C.B.M	SIZE
Packing	1	12.15kg	13.6kg	0.12	390x340x920mm
10.547	Graphic Size:	670x2300mm x2 700x2300mm x3			

LAREDO 3x3



* Spotlights at this page are available but not included



* Spotlights at this page are available but not included

POP UP DETAILS

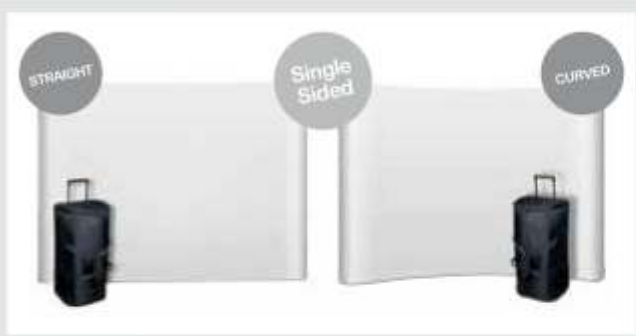

POP UP DETAILS



DIMENSIONS

*mm

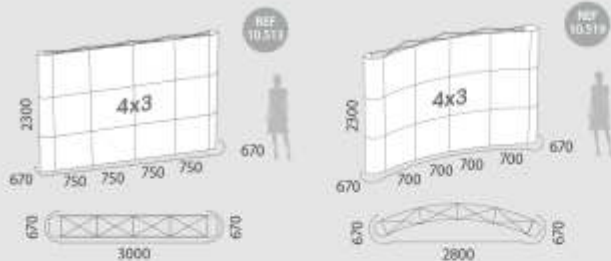

INFORMATION

Laredo 4x3 Pop Up features a straight or curved brushed aluminum frame that is lightweight, yet sturdy. Custom graphics attach to the frame with magnetic loop strips, yet with adhesive to the magnetic strip (1 strip roll is included). Also, 1 nylon trolley carry bag with wheels is included. This portable Pop Up can be set up and taken down in a few minutes. Ideal for enhancing your business's presence at your next media event, exhibition, tradeshow or convention.

4x STRAIGHT	QTY	N.W	G.W	C.B.M	SIZE
Packing	1	21.7kg	22.9kg	0.2	300x340x620mm
10.513	Graphic Size:		670x2300mm x2 750x2300mm x4		

4x CURVED	QTY	N.W	G.W	C.B.M	SIZE
Packing	1	21.7kg	22.9kg	0.2	390x340x620mm
10.519	Graphic Size:		670x2300mm x2 700x2300mm x4		

LAREDO 4x3



* Specifications at this page are available but not included



* Specifications at this page are available but not included

POP UP DETAILS



POP UP INSTALLATION



DIMENSIONS

*mm

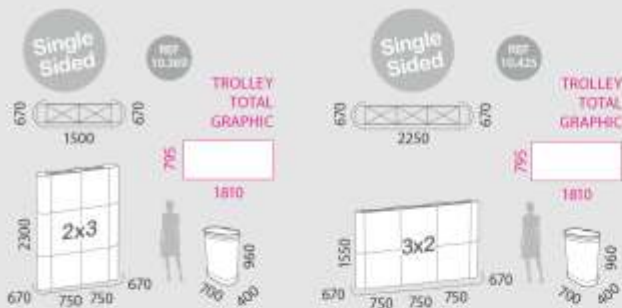

INFORMATION

Madrigal portable Pop-Up features a 2x3 or 3x2 brushed aluminum frame that is lightweight yet sturdy. Custom graphics attach to the frame with magnetic loop strips, yet with adhesive to the magnetic strip (1 strip roll is included). With 2 spotlights, also it includes 1 trolley hard-case with wheels that can be used as a customizable counter (printing is available but not included). Ideal for enhancing your business's presence at your next media event, exhibition, tradeshow or convention.

MADRIGAL 2x3	QTY	N.W	G.W	C.B.M	SIZE
Packing	1	24.4kg	27.6kg	0.32	730x430x1010mm
10.369	Graphic Size:		670x2300mm x2 750x2300mm x2		
MADRIGAL 3x2	QTY	N.W	G.W	C.B.M	SIZE
Packing	1	28.8kg	32kg	0.32	720x430x1010mm
10.425	Graphic Size:		670x1550mm x2 750x1550mm x3		

MADRIGAL 2x3 | 3x2
STRAIGHT



POP UP DETAILS



DIMENSIONS

*mm

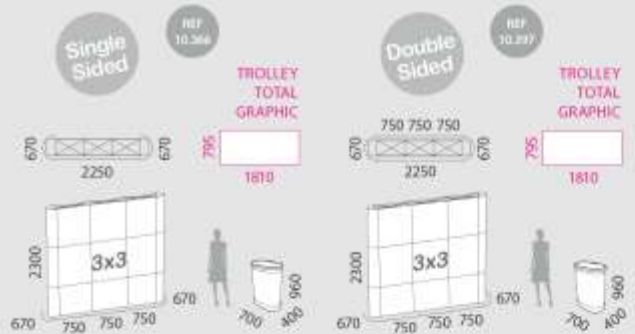

INFORMATION

Madrugal portable 3x3 Straight Pop Up features a brushed aluminum frame which is single-sided or double sided available. Custom graphics attach to the frame with magnetic loop strips, yet with adhesive to the magnetic strip (1 strip roll is included). With 2 spotlights, also it includes 1 trolley hard-case with wheels that can be used as a customizable counter (printing is available but not included). Ideal for enhancing your business's presence at your next media event, exhibition, tradeshow or convention.

ARTICLE'S	QTY	N.W	G.W	C.B.M	SIZE
Packing	1	32.25kg	38.45kg	0.32	730x400x1010mm
10.366	Graphic Size:	670x2300mm x2 750x2300mm x3			

ARTICLE'S	QTY	N.W	G.W	C.B.M	SIZE
Packing	1	34.75kg	37.95kg	0.32	730x400x1010mm
10.397	Graphic Size:	670x2300mm x2 750x2300mm x6			

MADRIGAL 3x3
STRAIGHT



POP UP DETAILS



DIMENSIONS

*mm

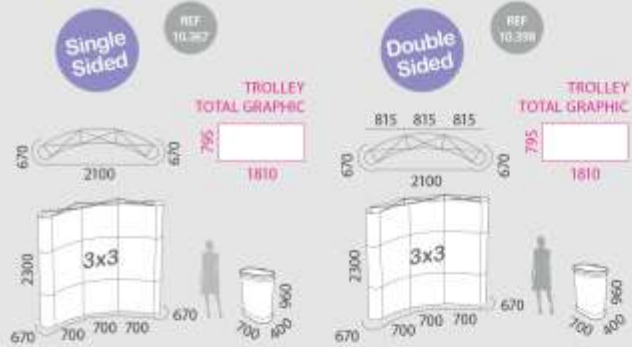

INFORMATION

Madrigal portable: 3x3 Curved Pop Up features a brushed aluminum frame which is single-sided or double sided available. Custom graphics attach to the frame with magnetic loop strips, yet with adhesive to the magnetic strip (1 strip roll is included). With 2 spotlights, also it includes 1 trolley hard-case with wheels that can be used as a customizable counter (printing is available but not included). Ideal for enhancing your business's presence at your next media event, exhibition, tradeshow or convention.

REF	QTY	N.W	G.W	C.B.M	SIZE
Packing	1	32.25kg	36.41kg	0.32	730x400x600mm
10.367	Graphic Size:	670x2300mm x2 700x2300mm x3			

REF	QTY	N.W	G.W	C.B.M	SIZE
Packing	1	34.75kg	37.94kg	0.32	730x400x600mm
10.398	Graphic Size:	670x2300mm x2 700x2300mm x3 815x2300mm x3			

MADRIGAL 3x3
CURVED



POP UP DETAILS



DIMENSIONS

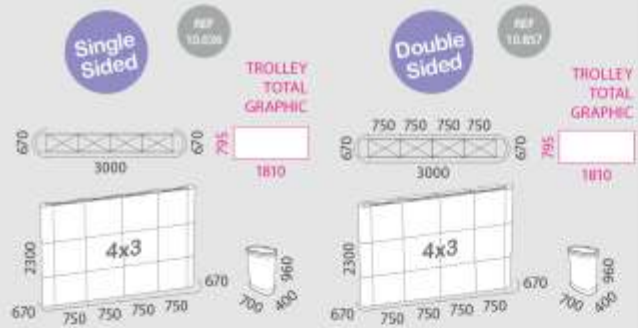

INFORMATION

Madrigal portable 4x3 Straight Pop Up features a brushed aluminum frame which is single-sided or double sided available. Custom graphics attach to the frame with magnetic loop strips, yet with adhesive to the magnetic strip (1 strip roll is included). With 2 spotlights, also it includes 1 trolley hard-case with wheels that can be used as a customizable counter (printing is available but not included). Ideal for enhancing your business's presence at your next media event, exhibition, tradeshow or convention.

REF	QTY	N.W	G.W	C.B.M	SIZE
-----	-----	-----	-----	-------	------

Packing	1	16.3kg	19.9kg	0.32	730x430x610mm
---------	---	--------	--------	------	---------------

10.036	Graphic Size:		670x2300mm x2		
			750x2300mm x4		

REF	QTY	N.W	G.W	C.B.M	SIZE
-----	-----	-----	-----	-------	------

Packing	1	44.5kg	47.9kg	0.32	730x430x610mm
---------	---	--------	--------	------	---------------

10.857	Graphic Size:		670x2300mm x2		
			750x2300mm x8		

MADRIGAL 4x3
STRAIGHT



POP UP DETAILS



DIMENSIONS

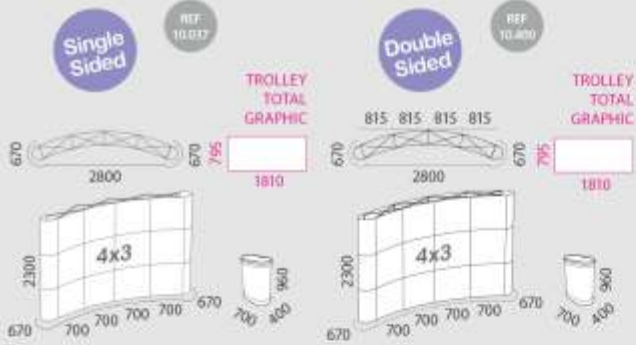

INFORMATION

Madrigal portable 4x3 Curved Pop Up features a brushed aluminum frame which is single-sided or double-sided available. Custom graphics attach to the frame with magnetic loop strips, yet with adhesive to the magnetic strip (1 strip roll is included). With 2 spotlights, also it includes 1 trolley hard-case with wheels that can be used as a customizable counter (printing is available but not included). Ideal for enhancing your business's presence at your next media event, exhibition, tradeshow or convention.

REF	SIDE	QTY	N.W	G.W	C.B.M	SIZE
-----	------	-----	-----	-----	-------	------

Packing	1	36.3kg	285kg	0.32	700x430x1010mm	
---------	---	--------	-------	------	----------------	--

10.037						670x2300mm x2 700x2300mm x4
--------	--	--	--	--	--	--------------------------------

REF	SIDE	QTY	N.W	G.W	C.B.M	SIZE
-----	------	-----	-----	-----	-------	------

Packing	1	44.5kg	417kg	0.32	700x430x1010mm	
---------	---	--------	-------	------	----------------	--

10.400						670x2300mm x2 700x2300mm x4 815x2300mm x4
--------	--	--	--	--	--	---

MADRIGAL 4x3
CURVED



POP UP DETAILS



DIMENSIONS

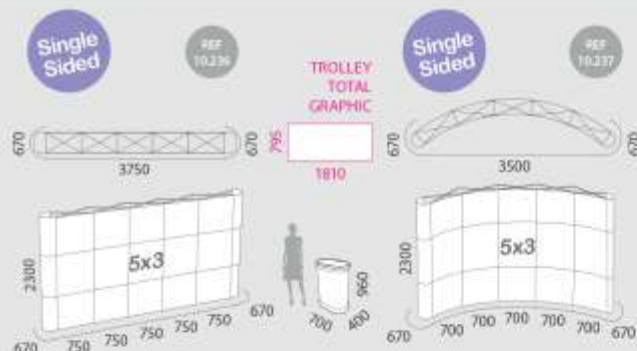

INFORMATION

Madrigal portable 5x3 Pop Up features a brushed aluminum frame which is straight shaped or curved shaped available. Custom graphics attach to the frame with magnetic loop strips, yet with adhesive to the magnetic strip (1 strip roll is included). With 2 spotlights, also it includes 1 trolley hard-case with wheels that can be used as a customizable counter (printing is available but not included). Ideal for enhancing your business's presence at your next media event, exhibition, tradeshow or convention.

5x3 STRAIGHT	QTY	N.W	G.W	C.E.M	SIZE
Packing	1	40.kg	43.kg	0.32	730x430x1030mm
10.236	Graphic Size:		670x2300mm x2 750x2300mm x5		

5x3 CURVED	QTY	N.W	G.W	C.E.M	SIZE
Packing	1	40.kg	43.kg	0.32	730x430x1030mm
10.237	Graphic Size:		670x2300mm x2 700x2300mm x5		

MADRIGAL 5x3



POP UP DETAILS

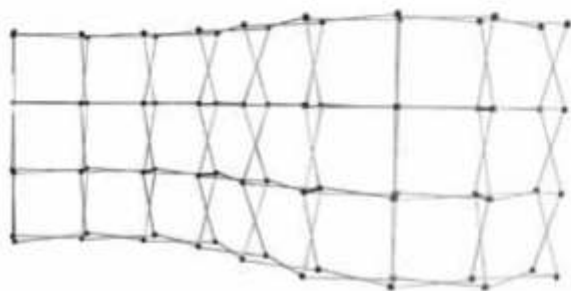

DIMENSIONS

*mm

Double Sided

REF: 10.234

TROLLEY TOTAL GRAPHIC

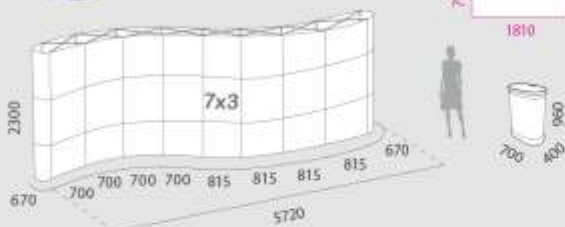

INFORMATION

Teide 8x3 double sided display is the biggest Pop Up, featuring a brushed aluminum frame. Custom graphics attach to the frame with magnetic loop strips, yet with adhesive to the magnetic strip (1 strip roll is included). With 4 spotlights for accenting your graphics. Also, it includes 2 trolley hard-cases with wheels that can be used as counters, and wraps for the cases can be customized with printed graphics (printing is available but not included). Ideal for enhancing your business's presence at your next media event, exhibition, tradeshow or convention.

TABLES	QTY	N.W	G.W	C.B.M	
Packing	2	35.6kg 30kg	36.6kg 30kg	0.32 0.32	730x430x1030mm 730x430x1030mm
10.234	Graphic Size:		670x2300mm x2 700x2300mm x8 815x2300mm x8		

TEIDE 8x3

Biggest Pop-Up

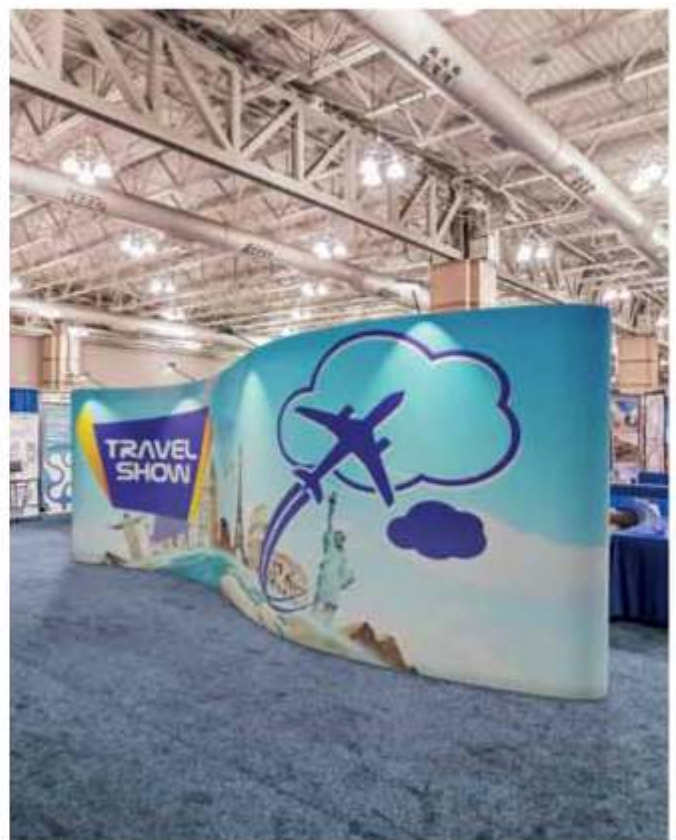

ESCALONA SOFT-CASE TROLLEY



INFORMATION

Made of Nylon with closures and zippers, 2 handle straps, 1 extendable handle and wheels. Escalona is ideal for protecting and transporting Pop Ups.

ESCALONA	QTY	N.W	G.W	C.B.M	SIZE
Packing	1	19kg	18.0kg	0.07	660x170x1030mm
10.060	Trolley Size: 420x420x790mm				

NOVES HARD-CASE TROLLEY



INFORMATION

Made of hard PVC, design lasts through long-term uses. Includes high-quality clasps and rubber wheels. Ideal for being labelled and used as counter.

NOVES	QTY	N.W	G.W	C.B.M	SIZE
Packing	1	7kg	9.3kg	0.18	430x430x1000mm
10.059	Graphic size for Counter: 1450x745mm				

MAQUEDA TROLLEY HARD-CASE



INFORMATION

Made of hard PVC, design lasts through long-term uses. Includes high-quality clasps, rubber wheels and handles. Ideal for carrying case makes easy to transport your trade show accessories and exhibits in between events.

MAQUEDA	QTY	N.W	G.W	C.B.M	SIZE
Packing	1	10kg	15.2kg	0.12	710x420x1010mm
10.058	Trolley: 700x400x960mm Graphic: 1810x795mm				

TABLE TOP FOR POP UP



INFORMATION

Includes nylon carry bag with ID Pocket and handles. Black or Silver color available. Foldable for transportation. Ideal to consolidate your trolley as a promotional counter, providing more surface to display in your event presentation.

TABLE TOP	QTY	N.W	G.W	C.B.M	SIZE
Unit	1	4.2kg	5.0kg	0.06	830x270x220mm
10.309	785x480x16mm				
10.310					

TROLLEY SOFT-CASE



INFORMATION

Trolley made of black nylon with closures and zippers, 2 handle straps, 1 extendable handle and wheels.

TROLLEY S.C.1	QTY	N.W	G.W	C.B.M	SIZE
Packing	1	3.7kg	3.3kg	0.11	456x265x1080mm
13.456	420x230x1080mm				

TROLLEY SOFT-CASE



INFORMATION

Trolley made of black nylon with closures and zippers, 2 handle straps, 1 extendable handle and wheels.

TROLLEY S.C.2	QTY	N.W	G.W	C.B.M	SIZE
Packing	1	4.18kg	5.9kg	0.12	440x340x120mm
13.457	420x275x670mm				

* Counter is not included / * Preenhoar non inclus / * Balcao não incluido / * Mostrador no incluido

* Counter is not included / * Preenhoar non inclus / * Balcao não incluido / * Mostrador no incluido

TOP AND BOTTOM BAR GRAPHIC (3x3)

- EN Top and bottom bars pack for Pop Up 3x3.
- FR Kit de bandes de suspension pour Pop Up 3x3.
- PT Kit de tiras de suspensão para Pop Up 3x3.
- ES Pack de Perchas/Zócalos para Pop Up 3x3.



TOP AND BOTTOM BAR GRAPHIC (4x3)

- EN Top and bottom bars pack for Pop Up 4x3.
- FR Kit de bandes de suspension pour Pop Up 4x3.
- PT Kit de tiras de suspensão para Pop Up 4x3.
- ES Pack de Perchas/Zócalos para Pop Up 4x3.

INFORMATION 3x3 Pop Ups

- Available Pack of 10 bars for Straight 3x3 Pop Up (5 Bottom and 5 Top).
- Available Pack of 6 bars for Back curved 3x3 Pop Up (3 Bottom and 3 Top).
- Available Pack of 10 bars for Front curved 3x3 Pop Up (5 Bottom and 5 Top).

STRAIGHT BAR	QTY	N.W	G.W	C.B.M	SIZE
Packing	10	0.68kg	0.7kg	0.0008	55x20x150mm
10.714	Straight 3x3		Pack: 5 Bottom + 5 Top		

C.FRONT BAR	QTY	N.W	G.W	C.B.M	SIZE
Packing	10	0.7kg	0.72kg	0.0007	55x20x150mm
10.715	Curved/Front 3x3		Pack: 5 Bottom + 5 Top		

C.BACK BAR	QTY	N.W	G.W	C.B.M	SIZE
Packing	6	0.4kg	0.41kg	0.0004	55x16x90mm
10.491	Curved/Back 3x3		Pack: 3 Bottom + 3 Top		

INFORMATION 4x3 Pop Ups

- Available Pack of 12 bars for Straight 4x3 Pop Up (6 Bottom and 6 Top).
- Available Pack of 8 bars for Back curved 4x3 Pop Up (4 Bottom and 4 Top).
- Available Pack of 12 bars for Front curved 4x3 Pop Up (6 Bottom and 6 Top).

STRAIGHT BAR	QTY	N.W	G.W	C.B.M	SIZE
Packing	12	0.83kg	0.85kg	0.0008	55x20x150mm
10.716	Straight 4x3		Pack: 6 Bottom + 6 Top		

C.FRONT BAR	QTY	N.W	G.W	C.B.M	SIZE
Packing	12	0.78kg	0.8kg	0.0007	55x20x150mm
10.717	Curved/Front 4x3		Pack: 6 Bottom + 6 Top		

C.BACK BAR	QTY	N.W	G.W	C.B.M	SIZE
Packing	8	0.6kg	0.62kg	0.0004	55x16x90mm
10.492	Curved/Back 4x3		Pack: 4 Bottom + 4 Top		

MAGNETIC BAR

- EN Magnetic bar. Suitable for models: Madrigal, Gredos, Arévalo, Laredo and Llanes.
- FR Barre magnétique. Compatible avec: Madrigal, Gredos, Arevalo, Laredo et Llanes.
- PT Barra magnética compatível com: Madrigal, Gredos, Arevalo, Laredo, Llanes.
- ES Barra magnética. Válida en modelos: Madrigal, Gredos, Arévalo, Laredo y Llanes.



720mm bar for Pop Up

INFORMATION

- See model of Pop Up for compatibility.
- With rail to insert the adhesive magnetic strip.
- Bars for construction of magnetic structures for Pop Ups.

MAGNETIC BAR	QTY	N.W	G.W	C.B.M	SIZE
Packing	1	0.2kg	0.22kg	0.0003	50x10x720mm
10.419	720mm				

MAGNETIC STRIP ROLL 12mm

- EN Magnetic strip roll, 50 metres length for fixing Pop Up graphics.
- FR Rouleau magnétique de 50m pour la fixation des images au Pop Up.
- PT Roio magnético com 50 metros para fixar impressões de Pop Up.
- ES Rollo de iman de 50 metros para la fijación de gráficas de Pop Up.



INFORMATION

- 50m Roll.
- 2mm thickness strip.
- One adhesive side for fixing to the graphics.



M.STRIP ROLL	QTY	N.W	G.W	C.B.M	SIZE
Packing	1	1.4kg	1.82kg	0.0018	100x20x150mm
10.360	50m roll				

EN PVC pannel for Pop Up.
FR Panneau en PVC pour Pop Up.

PT Painel de PVC para Pop Up.
ES Panel de PVC para Pop Up.

PVC PANNEL FOR POP UPS



high-quality
white 0.4mm PVC

INFORMATION

* mm

- Made of 0.4mm white PVC.
- Ideal for printing graphics for Pop Up.



PVC PANNEL	QTY	N.W	G.W	C.B.M	SIZE
Packing	1	1.15kg	2.5kg	0.05	110x130x880mm
10.101		±2350 / 2400x880x0.4mm			

CONNECTING PIECES FOR POP UPS



PLASTIC PIECE FOR MAGNETIC BAR

PLASTIC PIECE FOR POP UP CORNER

PLASTIC PIECE FOR BAR GRAPHICS

* mm



PIECE	QTY	N.W	G.W	C.B.M	SIZE
Packing	1	0.04kg	0.05kg	0.00002	50x50x10mm
10.858		50x50x10mm			

CORNER	QTY	N.W	G.W	C.B.M	SIZE
Packing	1	0.038kg	0.038kg	0.00007	50x50x20mm
10.409		50x50x20mm			

PIECE	QTY	N.W	G.W	C.B.M	SIZE
Packing	1	0.02kg	0.02kg	0.00006	60x50x10mm
10.859		60x50x10mm			

CROSS FOR TEXTIL POP UPS



INFORMATION

Cross of replacement for structures on Pop Ups with genuine VELCRO® brand system.

CROSS PU	QTY	N.W	G.W	C.B.M	SIZE
Packing	1	0.70kg	0.80kg	0.005	80x80x80mm
96.117					

HORIZONTAL CROSS FOR MAGNETIC POP UPS



INFORMATION

One unit cross of replacement for structures on Pop Ups with magnetic system.

HORIZONTAL C.	QTY	N.W	G.W	C.B.M	SIZE
Packing	1	0.70kg	0.80kg	0.005	80x80x80mm
10.897					

* VELCRO® is a registered trademark of Velcro BuSA. | VELCRO® est une marque déposée de Velcro Industries B.V. | VELCRO® is a registered trademark of Velcro Industries B.V. | VELCRO® es una marca registrada de Velcro Industrias B.V.

SPOTLIGHT DETAILS



INFORMATION

*mm

- Clamp base.
- 10W LED light included.
- Ideal for illuminating your exhibit booth and shed light on your displayed products and promotions.



ECONOMICS	QTY	N.W	G.W	C.B.M	SIZE	
Packing	30	0.3kg	11kg	0.003	80x51x110mm	
13.753			10 W		18V	

ECONOMIC LED SPOTLIGHT FOR POP UP



SPOTLIGHT FOR POP UP



INFORMATION

*mm

- Double clamp base.
- 150w light included.
- Ideal for illuminating your exhibit booth and shed light on your displayed products and promotional services.



SPOTLIGHT	QTY	N.W	G.W	C.B.M	SIZE
Packing	1	0.55kg	0.7kg	0.003	100x90x110mm
10.368			150 w		

OXFORD BAG FOR POP UP SPOTLIGHTS

BAG DETAILS



easy transport by handle



INFORMATION

*mm

- Made of black nylon and all crossed zipped.
- The Oxford Bag protects and extends the life of your Pop Up Spotlights. Easy transport by handles.



OXFORD BAG	QTY	N.W	G.W	C.B.M	SIZE
Packing	1	0.15kg	0.20kg	0.002	100x30x40mm
13.455					

*Spotlights not included / *Spotlights non inclus / *Focos no incluidos / *Focos no incluidos.

TAVIRA

COUNTER DETAILS



COUNTER DETAILS



DIMENSIONS

ARTWORK

*mm

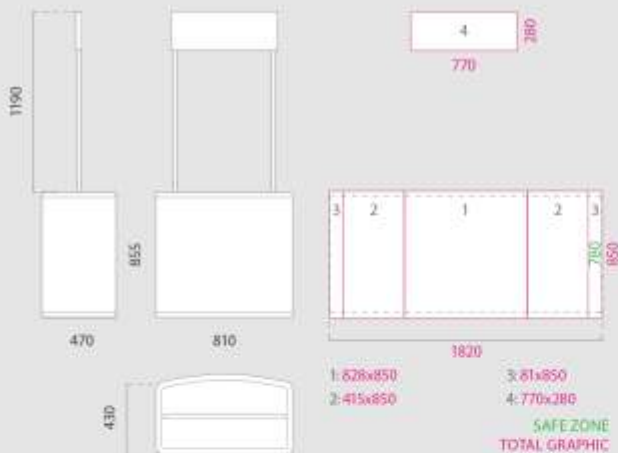

INFORMATION

This counter comes with carry bag and exhibitors can quickly assemble it in a few minutes (no tools required). Once it has been assembled, the counter is lightweight enough to be moved with ease by one person. It has 1 plastic shelf in the interior, so the extra brochures, business cards and flyers can be stored out of sight so your exhibition always appears clean and organized. This counter has a header of 770x280mm for displaying company logos or graphs. Each counter that comes with a header, is excellent for tradeshow and promotional events at stores or business presentations.

TAVIRA	DTF	N.W	G.W	C.E.M	SIZE
Parking	1	7.35kg	8.96kg	0.071	840x100x880mm

10.098 Total Size Counter: 810x470x2045mm



COUNTER DETAILS



EXTERNAL SIZE

ARTWORK

*mm

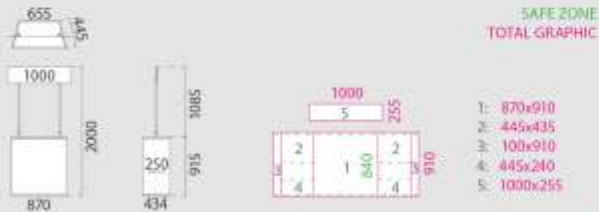

INFORMATION

The Salmoral Counter has 1 plastic shelf in the interior of the display for a better storing and it includes a nylon carry bag. This lightweight counter has a header of 1000x255mm for displaying company logos or graphs. Exhibitors can quickly assemble it in less than 5 minutes (no tools required). Excellent for tradeshows and promotional acts at stores, supermarkets or for business presentations.

SALMORAL	QTY	N.W	G.W	C.E.M	SIZE
Packing	1	6.8kg	8.29kg	0.09	960x70x1000mm
10.043	Total Size Counter: 1000x434x2000mm				

SALMORAL



COUNTER DETAIL

EXTERNAL SIZE

ARTWORK

*mm

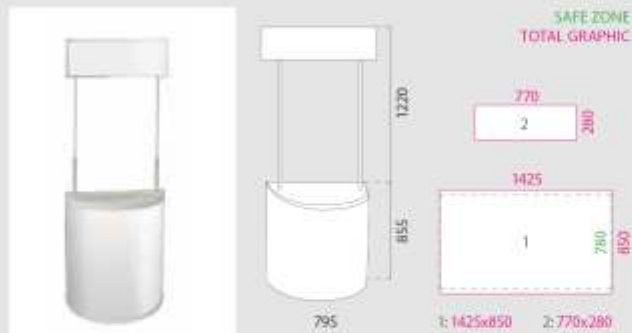

INFORMATION

This counter comes with carry bag and exhibitors can quickly assemble it in a few minutes (without tools). It has 1 plastic shelf in the interior of the display. Belvis features an accessible semicircular design. This counter has a header of 770x280mm for displaying company logos or graphs. Ideal for tradeshows and promotional events at any stores or business presentations.

BELVIS	QTY	N.W	G.W	C.E.M	SIZE
Packing	1	5.8kg	7.7kg	0.09	880x20x1700mm
10.719	Total Size Counter: 795x440x2075mm				

BELVIS



COUNTER DETAIL DIMENSIONS ARTWORK *mm

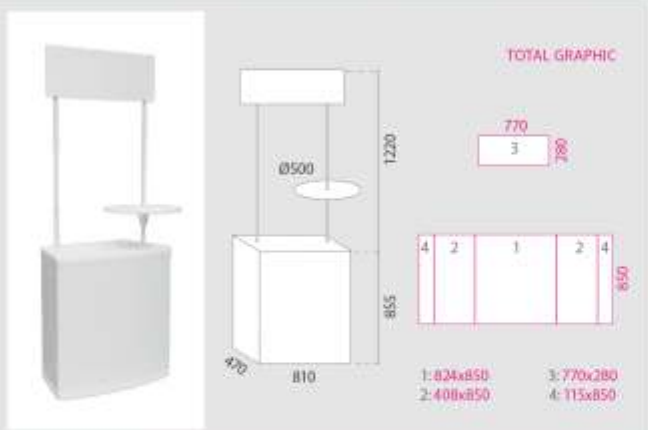

INFORMATION

This counter comes with carry bag and exhibitors can quickly assemble it in a few minutes (no tools required). It has 1 circular Ø500mm shelf for one pole and 1 plastic shelf in the interior of the display. This counter has a header of 770x280mm for displaying company logos or graphs. It is excellent for tradeshow and promotional events at stores or business presentations.

MANCHESTER	QTY	N.W	G.W	C.E.M	SIZE
Packing	1	8.5kg	10.5kg	0.08	810x470x1220mm
10.676	Total Size Counter: 810x470x2075mm				

MANCHESTER



COUNTER DETAIL DIMENSIONS ARTWORK *mm

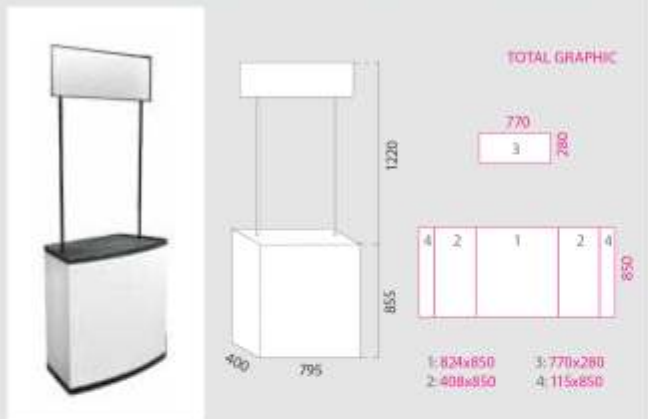

INFORMATION

This counter comes with carry bag and exhibitors can quickly assemble it in less than 5 minutes (no tools required). It has 1 plastic shelf in the interior of the display. Featuring a sleek blackened look design, allowing the display to stand out against any background. With a displaying header of 770x280mm, Lake Counter is excellent for tradeshow, stores or business presentations.

LAKE	QTY	N.W	G.W	C.E.M	SIZE
Packing	1	8.5kg	9.5kg	0.08	810x470x1220mm
10.675	Total Size Counter: 795x400x2075mm				

LAKE



COUNTER DETAILS



ARTWORK *mm



TOTAL GRAPHIC

1: 1004x858
2: 322x858

INFORMATION

This Counter has an aluminium frame and two internal shelves to give the promo stands support and provide storage space. Also it features 2 lockable doors. The top counter shelf has a wooden finish, yet attractive display. It is assembled and disassembled quickly and stored into a carrying bag.

SIGÜENZA	QTY	N.W	G.W	C.E.M	SIZE
Packing	1	27kg	30kg	0.23	850x200x290mm
10.493					

SIGÜENZA



COUNTER DETAILS



ARTWORK *mm

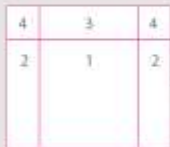

TOTAL GRAPHIC

1: 1004x858 3: 1122x227
2: 322x858 4: 212x227

INFORMATION

The Sepulveda Counter has an aluminium frame and 3 shelves (2 internal) to give the stands support and provide storage space, with third shelf the counter has an added desk. Also features 2 lockable doors. The top counter shelf has a wooden finish. It is assembled and disassembled quickly and stored into a carrying bag.

SEPULVEDA	QTY	N.W	G.W	C.E.M	SIZE
Packing	1	36.8kg	41.9kg	0.18	940x850x1190mm
10.494					

SEPULVEDA



COUNTER DETAILS

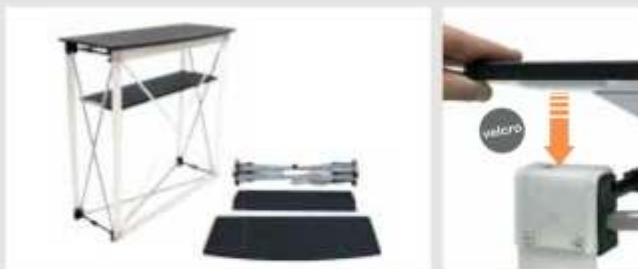

EXTERNAL SIZE



ARTWORK

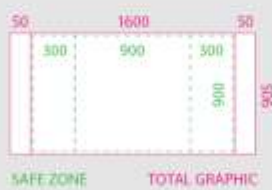

INFORMATION

Ajalvir is a very fast assembly counter thanks to its genuine VELCRO® brand fasteners system. Features 2 blackened wooden shelves (foldable top) and a carry bag. Ideal for tradeshows, promotional events at stores or business presentations.

AIJALVIR	QTY	N.W	G.W	C.E.M	SIZE
Packing	1	8.35kg	115kg	0.0609	790x210x1000mm
10.323	Graphic Size: 905x1600mm				

AJALVIR



COUNTER DETAILS



EXTERNAL SIZE



ARTWORK

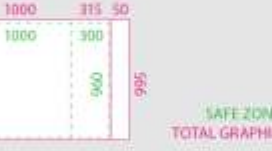

INFORMATION

Villares is a very fast assembly counter thanks to its genuine VELCRO® brand fasteners system. Features 2 blackened wooden shelves (foldable top) and a carry bag. Ideal for tradeshows, promotional events at stores or business presentations.

VILLARES	QTY	N.W	G.W	C.E.M	SIZE
Bottom	1	1.1kg	6.85kg	0.12	445x230x1100mm
Top	1	5.49kg	6.6kg	0.04	465x710x1100mm
10.096	Graphic Size: 1730x995mm				

VILLARES



* VELCRO® is a registered trademark of Velcro (USA). | VELCRO® est une marque déposée de Velcro Industries S.V. | VELCRO® is a trade mark registered de Velcro Industries B.V. | VELCRO® es una marca registrada de VelcroIndustries B.V.

COUNTER DETAILS



EXTERNAL SIZE



ARTWORK



INFORMATION

Cezures counter features a black wooden countertop and base. A carrying bag with handles is included. It can be used to hold promotional materials, also known as a portable stand, can be used to conduct a product demonstration. Easy and fast to set up thanks to its genuine VELCRO® brand fasteners system.

CEZURES	QTY	N.W	G.W	C.E.M	SIZE
Packing	2	1.7kg	10kg	0.02	1700x900x40mm
10.686	Graphic Size: 1700x900mm				

CEZURES



COUNTER DETAILS



DIMENSIONS



ARTWORK

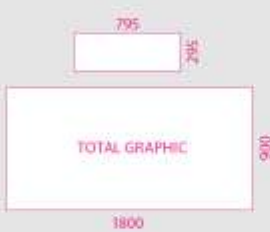

INFORMATION

The Atenas Counter features a black wooden countertop and base. Also, it has 1 plastic shelf in the interior and a top header of 795x295mm for displaying your message. A fabric carrying bag with handles is included. Easy and fast to set up thanks to its genuine VELCRO® brand fasteners system. It is ideal for being used at tradeshow, media events or business presentations.

ATENAS	QTY	N.W	G.W	C.E.M	SIZE
Packing	1	25.3kg	27kg	0.21	1800x440x940mm
10.312	Graphic Size: 1800x900mm				

ATENAS



* VELCRO® is a registered trademark of Velcro (USA). | VELCRO® set van merknaam eigendom van Velcro Industries B.V. | VELCRO® is een gereguleerde naam van Velcro Industries B.V. | VELCRO® is una marca registrada de Velcro Industries B.V. | VELCRO® is (ata marca) registrada de Velcro Industries B.V.

COUNTER DETAILS



CAEN



DIMENSIONS

ARTWORK

*mm

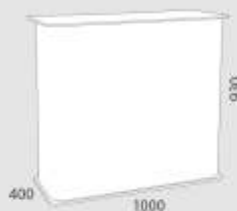

TOTAL GRAPHIC



INFORMATION

This counter comes with carry bag and exhibitors can quickly assemble it in a few minutes (no tools required) thanks to its genuine VELCRO® brand fasteners system. Once it has been assembled, the counter is lightweight enough to be moved with ease by one person. It has 1 shelf in the interior, so the extra brochures, business cards and flyers can be stored out of sight so your exhibition always appears clean and organized. This counter features wood or black finish available. Ideal for tradeshowes and promotional events at stores or business presentations.



CAEN	DTY	N.W	G.W	C.E.M	SIZE
Packing	1	16kg	16kg	0.2012	1290x300x620mm
13.845-1		Graphic Size: 2195x900mm			
13.845-2		Graphic Size: 2195x900mm			

* VELCRO® is a registered trademark of Velcro NV/SA. | VELCRO® est une marque déposée de Velcro Industries B.V. | VELCRO® is a trade mark registered de Velcro Industries B.V. | VELCRO® es una marca registrada de VelcroIndustriaes S.V.

COUNTER DETAILS



EXTERNAL SIZE

ARTWORK

*mm



INFORMATION

The Valdes Counter features a circular design that allows the integration of the counter in any space for exhibition and with the advantage of being more accessible than other counters. It has a black wooden countertop and base. It is fast and easy to setup in seconds. A carrying bag with handles is included.

VALDES	QTY	N.W	G.W	C.B.M	SIZE
Packing	2	3.8kg	4.3kg	0.016	460x900x800mm
		2.7kg	3.2kg	0.037	200x200x930mm
10.685		Graphic Size: 1225x900mm			

VALDES



COUNTER DETAILS



EXTERNAL SIZE

ARTWORK

*mm

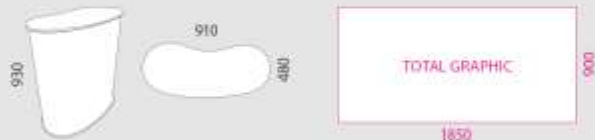

INFORMATION

The Doiras Counter features a black wooden countertop and base. Also, it has 1 plastic shelf in the interior for storing. A nylon carrying bag with handles is included. Doiras Counter is easy to set-up and breakdown in only a few seconds, making it perfect for travelling business people.

DOIRAS	QTY	N.W	G.W	C.B.M	SIZE
Packing	2	12kg	16kg	0.037	300x900x930mm
		1.5kg	2kg	0.037	200x200x930mm
13.475		Graphic Size: 1850x900mm			
13.476					

DOIRAS

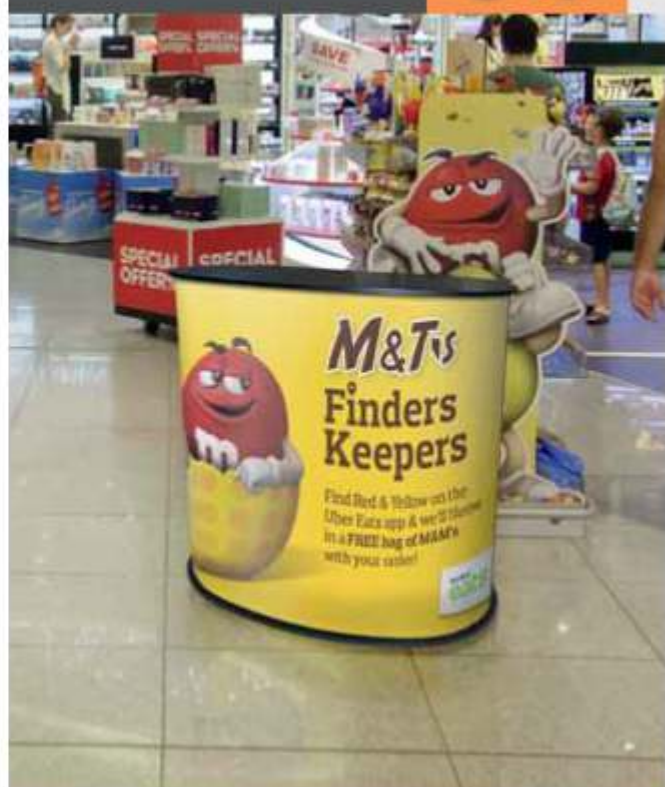

new

COUNTER DETAILS



DOIRAS XXL



DIMENSIONS

ARTWORK

*mm





TOTAL GRAPHIC

INFORMATION

Doiras XXL comes with carry bag and exhibitors can quickly assemble it in a few minutes (no tools required) thanks to its genuine VELCRO® brand fasteners system. Once it has been assembled, the counter is lightweight enough to be moved with ease by one person. It has 1 shelf in the interior, so the extra brochures, business cards and flyers can be stored out of sight so your exhibition always appears clean and organized. This counter features wood or black finish available. Ideal for tradeshow and promotional events at stores or business presentations.

CAEN	QTY	N.W	G.W	C.B.M	SIZE
Packing	1	11kg	16kg	0.220	450x300x450mm

13.846-1		Graphic Size: 1950x900mm
13.846-2		Graphic Size: 1950x900mm



* Full Up to 0246.2 example is available but not included. See it in Chapter 1 Displays

COUNTER DETAILS



DIMENSIONS

ARTWORK

*mm



INFORMATION

This stylish Promotion Counter is completely portable, functional and has 1 shelf in the interior of the display, so your exhibition always appears clean and organized. Also, there are 3 wooden finishes for the top: black, brown or yellow colored. The curved counter is lightweight and includes two carrying cases. Graphics are really easy to attach to the display thanks its magnetic system. Cebberos counter is ideal for various promotional needs and often used to hold product samples, corporate literature, business cards, brochures and more so counter is perfect for a wide variety of promotional applications, including in-store displays, such as grocery 'free sample' promotions.

CEBREROS1	QTY	N.W	G.W	C.E.M	SIZE
Bottom	1	1.50kg	0.55kg	0.06	380x60x1030mm
Top	1	6.7kg	0.35kg	0.04	460x106x150mm
10.241		Graphic Size: 2035x935mm			
CEBREROS2	QTY	N.W	G.W	C.E.M	SIZE
Bottom	1	1.50kg	0.55kg	0.06	380x60x1030mm
Top	1	6.7kg	0.35kg	0.04	460x106x150mm
10.392		Graphic Size: 2035x935mm			
CEBREROS3	QTY	N.W	G.W	C.E.M	SIZE
Bottom	1	1.50kg	0.55kg	0.06	380x60x1030mm
Top	1	6.7kg	0.35kg	0.04	460x106x150mm
10.042		Graphic Size: 2035x935mm			

CEBREROS



COUNTER DETAILS



*Printed on fabric.
Impresión en tela.
Impressão em tecido.
Impressão en tela.



BARACOA



EXTERNAL SIZE

ARTWORK

*mm

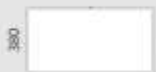
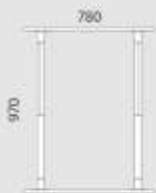

FRONT VIEW
SAFE ZONE
TOTAL GRAPHIC



INFORMATION

These Counters are designed for using with fabric wrap (printed on textile) making it lightweight and easy to fold. Also, the Fabric Counters are also simple to setup. All the aluminium poles fit together and snap into place. Simply stretch the wrap over the completed base and it's ready to use. With carry bag for easy travelling. Features a double zip to the interior of the counter for storing, so your exhibition always appears clean and organized. Baracoa is ideal as a lectern or podium at tradeshow, promotional events or conventions and are great to pair with Pop Up banners or any stand.

BARACOA	QTY	NW	GW	C.B.M.	SIZE
Packing	1	8kg	0.2kg	0.042	860x20x410mm
13.740	Graphic Size: 2130x1030mm				



COUNTER DETAILS

 *Printed on fabric.
Impresión sur tela.
Impressão em tecido.
Impresión en tela.



EXTERNAL SIZE *mm ARTWORK DOWNLOAD



INFORMATION

Creta is lightweight and easy to fold and setup. With carry bag and a single zip to the interior for storing. Features 3 points of view. Ideal as a lectern or podium at tradeshows, events or conventions.

CRETA	QTY	N.W	G.W	C.E.M	SIZE
Packing	1	1kg	10kg	0.04	650x100x610mm
10.311	Graphic Size: 1810x1030mm				

CRETA



COUNTER DETAILS

 *Printed on fabric.
Impresión sur tela.
Impressão em tecido.
Impresión en tela.

automatic hydraulic



EXTERNAL SIZE *mm ARTWORK DOWNLOAD



INFORMATION

Siena is lightweight and easy to fold and setup. With a hard carry padded bag and a double zip. Features an **hydraulic drive system** for an automatic and quick unfolding with just a slight push on the top of the counter. Ideal for events or conventions and are great to pair with Pop Up banners or any stand.

SIENA	QTY	N.W	G.W	C.E.M	SIZE
Packing	1	5.6kg	76kg	0.21	1170x600x350mm
15.244	Graphic Size: 1650x890mm				

SIENA

AUTO UNFOLD



*Pricing is approximate but not included

COUNTER DETAILS



*Printed on fabric.
Impressão sur tole.
Impresión en tecido.
Impresión en tela.



EXTERNAL SIZE

*mm

ARTWORK

DOWNLOAD



FRONT VIEW SAFE ZONE TOTAL GRAPHIC

INFORMATION

Manacor is lightweight and fast to setup. Features an oval shape design. With carry bag and a double zip to the interior for storing. Ideal as a lectern or podium at tradeshows, events or conventions.

MANACOR	QTY	N.W	G.W	C.E.M	SIZE
Packing	1	70kg	744kg	0.0366	440x300x430mm
10.318	Graphic Size: 1480x1015mm				

MANACOR



COUNTER DETAILS



*Printed on fabric.
Impressão sur tole.
Impresión en tecido.
Impresión en tela.



EXTERNAL SIZE

*mm

ARTWORK

DOWNLOAD



FRONT VIEW SAFE ZONE TOTAL GRAPHIC

INFORMATION

Mahon is lightweight and easy to assembly. Features the classic raindrop shape design. With carry bag and a double zip to the interior for storing. Ideal as a lectern or podium at promotional events, tradeshows, point of sales.

MAHON	QTY	N.W	G.W	C.E.M	SIZE
Packing	1	10.30kg	10.93kg	0.0672	300x400x350mm
10.319	Graphic Size: 2070x1000mm				

MAHON



*Pricing is available but not included

VIDAGO PANEL BANNER

CONTENT

EN Magnetic Panel System. Using straight frames to which the graphic panel can be attached by means of magnetic strips.
 • 2 round steel bases. • 2 aluminum poles. • 2 spotlights.
 • Connectors. • 4 aluminum cases (700x1000mm).
 • 8 pieces of PS of panel.

FR Système de panneaux magnétiques. Affichage fixé sur cadre avec ruban magnétique.
 • 2 bases rondes en acier. • 2 poteaux en aluminium.
 • Connecteurs. • 4 cadres en aluminium (700x1000mm).
 • 8 pcs de panneau PS. • 2 foyers.

PT Sistema de painéis magnéticos. Os painéis são fixados nos marcos mediante barras magnéticas.
 • 2 bases redondas de aço. • 2 postes de alumínio.
 • 8 peças de painel PS. • 4 marcos de alumínio (700x1000mm).
 • 2 focos. • Conectores.

ES Sistema de panel magnético. Usando marcos rectos a los cuales el panel gráfico puede unirse por bandas magnéticas.
 • 2 bases redondas de acero. • 2 postes de aluminio.
 • 8 pcs PS panel. • 4 marcos de aluminio (700x1000mm).
 • 2 focos. • Conectores.



spotlights included



2 round steel bases



WALL DETAILS



INFORMATION

This exhibition display unit features 1 backdrop double-sided panel designed for 8 graphic panes. This unit can be easily assembled into an appealing pop up display thanks its magnetic system to fix the panes. Aluminium structure composed by 2 poles, 4 cases and 2 round bases made of steel. Also 2 spotlights are included. Pair this backdrop with some trade show fixtures available on this catalogue, such as counters, iPad mounts, chairs or brochure stands. The exhibition booths, offer a great way to market your business at trade shows, conventions, media events and expos.

VIDAGO	QTY	N.W	G.W	C.S.M	SIZE
Packing	1	14.5kg	38kg	0.40	800x400x290mm
10.430		Graphic Size: 2100x2000mm			

EXTERNAL SIZE

ARTWORK

*mm

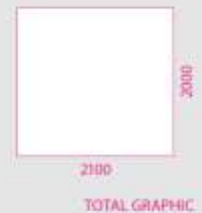

*Printing is available but not included

CATANIA

CONTENT

EN

Portable Display Wall. The construction makes an easy and fast assembly.
 • Aluminium Profile, base feet and two spotlights.
 • Oxford Cloth bag: 1 unit.

FR

Display portable, facile et rapide à monter.
 • Profils en aluminium, bases et foyers d'éclairage.
 • Valise de transport Oxford Cloth: 1 unité.

PT

Display portátil de fácil e rápida montagem.
 • Perfis de alumínio, bases e focos.
 • Mala de transporte Oxford Cloth: 1 unidade.

ES

Display portátil de fácil y rápido montaje.
 • Perfil de aluminio, bases y dos focos.
 • Bolsa de transporte: 1 unidad.



spotlights included



1 oxford bag included



WALL DETAILS



INFORMATION

This portable exhibition display unit features a lightweight, yet sturdy, aluminium profile structure. This unit can be easily assembled fast and easy. The entire portable display can be set up and taken down within minutes. It is composed by 1 aluminium frame structure, 2 round bases and 1 oxford bag for an easy transportation. Also 2 spotlights are included. Pair this backdrop wall with some trade show fixtures available on this catalogue, such as counters, iPad mounts, chairs or brochure stands. The exhibition booths, offer a great way to market your business at trade shows, conventions, media events or expos.

CATANIA	QTY	N.W	G.W	C.B.M.	SIZE
Packing	1	11kg	16.2kg	0.14	420x350x250mm
10.647		Size: 3000x2000mm			

EXTERNAL SIZE

*mm



2000

3000

*Printing is available but not included

PERUGIA

CONTENT

EN

Portable Display Wall. The construction makes an easy and fast assembly.
 • Aluminium Profiles, base feet and two spotlights.
 • Oxford Cloth bag: 1 unit.

FR

Visuel portable, facile et rapide à monter.
 • Profils en aluminium, bases et foyers d'éclairage.
 • Valise de transport-Oxford Cloth: 1 unité.

PT

Display portátil de fácil e rápida montagem.
 • Perfis de alumínio, bases e focos.
 • Mala de transporte-Oxford Cloth: 1 unidade.

ES

Display portátil de fácil y rápido montaje.
 • Perfil de aluminio, bases y dos focos.
 • Bolsa de transporte: 1 unidad.



2 spotlights included



Oxford bag included

INFORMATION

This portable exhibition display unit features a lightweight, yet sturdy, 2x3m aluminium profile structure. This unit can be easily assembled fast and easily. The entire portable display can be set up and taken down within minutes. It is composed by 1 aluminium frame structure, 2 round bases and 1 oxford bag for an easy transportation. Also 2 spotlights are included. Pair this backdrop wall with some trade show fixtures available on this catalogue, such as counters, iPad mounts, chairs or brochure stands. The exhibition booths, offer a great way to market your business at trade shows, conventions, media events or expos.

PERUGIA	QTY	N.W	G.W	C.S.M	ISEL
Packing	1	19kg	36.2kg	0.14	420x180x1230mm
10.648	Graphic Size: 3000x2000mm				

EXTERNAL SIZE

ARTWORK

*mm



3000

TOTAL GRAPHIC

*Printing is available but not included

LIMOGES

CONTENT

EN

Stable Exhibition System. Fast and easy assembly.
 • Aluminium frame 2000x2200mm.
 • Header Board, Shelves: 1.
 • Wings (2 units) (L&R). • V-Shape Table: 1.
 • Spotlights (2 units). • Plastic Packing Case.

TR

Système d'exposition stable. Montage facile.
 • Cadre en aluminium 2000x2200mm.
 • Ailes (2 unités) (L&R).
 • Plaque supérieure Étagère: 1. • "Table en "V": 1.
 • Foyers d'éclairage (2 unités). • Valièse en plastique.

PT

Sistema de exibição estável. De fácil montagem.
 • Marco de alumínio 2000x2200mm.
 • Placa superior. Prateleira: 1.
 • Alas (2 unidades) (L&R). • Mesa em forma de "V": 1.
 • Focos (2 unidades).
 • Mala de transporte em plástico.

ES

Sistema de exhibición estable de fácil montaje.
 • Marco de aluminio 2000x2200mm.
 • Placa superior. Estantes: 1.
 • 2 Alas (izquierda, derecha).
 • Mesa en forma de "V": 1.
 • 2 focos. • Maleta de plástico.



2 spotlights are included



hard case included

INFORMATION

This portable exhibition display unit features a lightweight, yet sturdy, 2x2m aluminium profile structure. This unit can be easily assembled fast and easily. The entire portable display can be set up in a few minutes. It's composed by 1 aluminium frame structure, 2 round bases, 1 header board, 2 sides wings, 1 shelf, 1 "V" table, 2 spotlights and 1 hard case. Pair this backdrop wall with some trade show fixtures available on this catalogue, such as counters, iPad mounts, chairs or brochure stands. The exhibition booths, offer a great way to market your business at trade shows, conventions, media events or expos.

LIMOGES	QTY	N.W	G.W	C.B.M.	QTY
Packing	1	52.5kg	54kg	0.44	290x390x1450mm
10.153					

EXTERNAL SIZE

ARTWORK

*mm

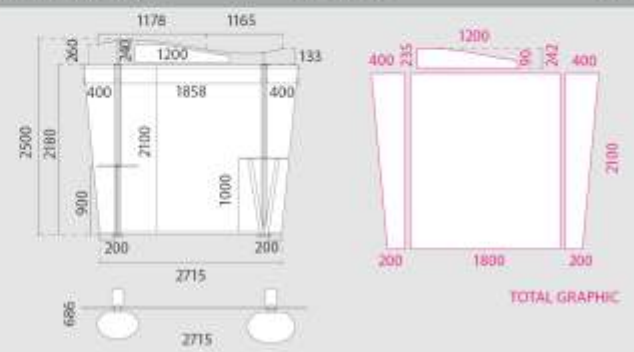

*Printing is available but not included

CONTENT

EN

Stable Exhibition System. Easy to be assembled.
 • Aluminium frame 2850x2200mm.
 • Header Board, Shelves: 3.
 • Wings (2 units) (L&R). • "V" Shape Table: 1.
 • Spotlights (3 units). • Plastic Packing Case.

FR

Système d'exposition stable. Montage facile.
 • Cadre en aluminium 2850x2200mm.
 • Plaque supérieur. Étagères: 3.
 • Ailes (2 unités) (L&R). • Foyers d'éclairage (3 unités).
 • Table en "V": 1. • Valise en plastique: 1 unité.

PT

Sistema de exibição estável. De fácil montagem.
 • Marco de alumínio 2850x2200mm.
 • Placa superior. Prateleiras: 3. • Alas (2 unidades) (L&R).
 • Mala de transporte em plástico: 1.
 • Mesa em forma de "V": 1. • Focos (3 unidades). Fixador de LCD.

ES

Sistema de exhibición estable. Fácil montaje.
 • Marco de aluminio 2850x2200mm.
 • Placa superior. Estantes: 3.
 • 2 Alas (izquierda, derecha). • Mesa en forma de "V": 1.
 • 3 focos. • Maleta de plástico.

OPOLE



includes 3 spotlights



hard case included



INFORMATION

Opole is a portable and elegant exhibition display unit formed by a sturdy, 2850x2200mm aluminium structure. This unit can be easily assembled fast and easily. The entire portable display can be set up in a few minutes. It's composed by 1 aluminium frame structure, 1 header board, 2 sides wings, 3 shelves, 1 "V" table, 3 spotlights and 1 hard case. Pair this backdrop wall with some trade show fixtures available on this catalogue, such as counters, iPad mounts, chairs or brochure stands. The exhibition booths, offer a great way to market your business at trade shows, conventions, media events or expos.

OPOLE	QTY	N.W.	G.W.	C.S.M.	SIZE
Packing	1	63.5kg	86kg	0.441	780x390x1150mm
10.192					

EXTERNAL SIZE

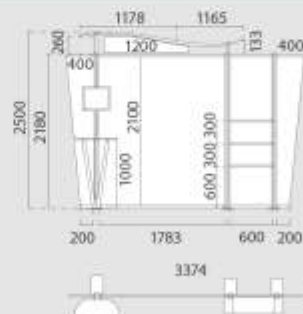

ARTWORK

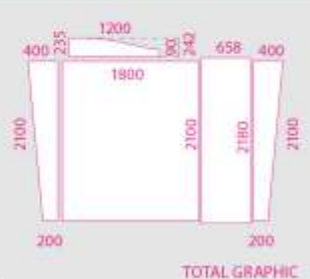

TOTAL GRAPHIC

* TV is not included. Printing is available but not included

KASSEL



includes 3 spotlights

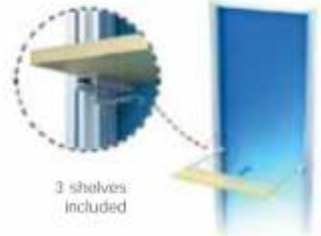

3 shelves included

hard case included



CONTENT

EN	Smart Exhibition System. Easy to be assembled. • Aluminium frame 2824x2400mm. • Header Board. • Counter. • Shelves 3. • Spotlights (3 units). • Plastic Packing Case.
FR	Système d'exposition stable. Montage facile. • Cadre en aluminium 2824x2400mm. • Plaque supérieur. • Comptoir. • Étagères 3. • Foyers d'éclairage (3 unités). • Valise.
PT	Sistema de exibição de fácil montagem. • Marco de alumínio 2824x2400mm. • Placa superior. • Prateleiras: 3. • Balcão. • Mala de transporte. • Focos (3 unidades).
ES	Sistema de exhibición de fácil montaje. • Marco de aluminio 2824x2400mm. • Placa superior. • Maleta de transporte. • Estantes: 3. • 3 focos. • Mostrador.

INFORMATION

Kassel is a portable and elegant -All in one- trade show booth unit formed by a sturdy, 2824x2400mm aluminium structure. This unit can be easily assembled fast and easily. The entire portable display can be set up in a few minutes. It's composed by 1 aluminium frame structure, 1 header board, 3 shelves, 1 counter, 3 spotlights and 1 hard case. Pair this tradebooth with some trade show fixtures available on this catalogue, such as Totems, iPad mounts, chairs or brochure stands. The exhibition booths, offer a great way to market your business at trade shows, conventions, media events or expos.

KASSEL	QTY	N.W	G.W	C.B.M	SIZE
Packing	1	85.5kg	96.95kg	0.441	780x390x1450mm

10.364

EXTERNAL SIZE

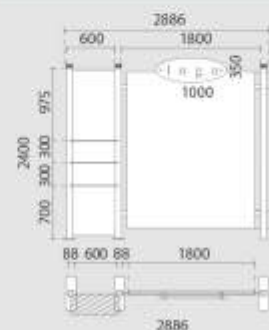

ARTWORK

*mm

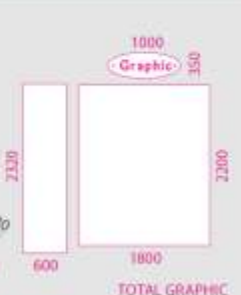

* Printing is available but not included

PESCARA

CONTENT

EN

Flexible Pop-Up wall system. Easy assembly.
 • Pop-Up 3x1: 3 units.
 • Corner Accessories: 3 units.
 • Plastic trolley Case: 2 units.

FR

Pop-Up magnétique facile à monter.
 • Pop-Up 3x1: 3 unités.
 • Accessoires pour les angles: 3 unités.
 • Valise de transport en plastique: 2 unités.

PT

Pop-Up magnético de fácil montagem.
 • Pop-Up 3x1: 3 unidades.
 • Acessórios das esquinas: 3 unidades.
 • Mala de transporte em plástico: 2 unidades.

ES

Sistema de Pop-Up flexible y de fácil montaje.
 • Pop-Up 3x1: 3 unidades.
 • Accesorios para esquinas: 3 unidades.
 • 2 Maletas de plástico.

2 trolley cases included



3 spaces divided to expose

WALL DETAILS



INFORMATION

Pescara is a flexible 3-walls booth graphics system made up of a Pop-up structure to create an impressive triple spaced trade show booth. With a top height of 2340mm, this event fixture features enough space for setting up counters, chairs or any display and create 3 conference environments for your business. Ideal for meeting one-on-one with potential customers at a trade show. Composed by a straight frame for 3 graphic sides and 3 corner accessories. The portable display breaks down quickly, fitting neatly into the 2 portable carrying bags (included) to transport back to your business or to the next event. The 2 trolley cases are made of heavy-duty molded plastic and features roller wheels, dual handles, and locking security.

EXTERNAL SIZE & ARTWORK

*mm

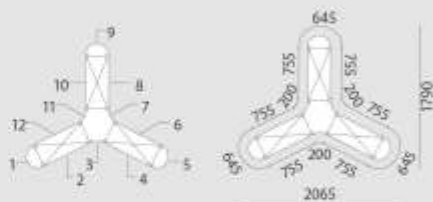

TOTAL GRAPHIC

PESCARA	QTY	N.W	G.W	C.B.M	SIZE
Packing	1	68.5kg	70kg	0.31	730x430x1000mm
				0.31	730x430x1000mm
10.639					

*Printing is available but not included

FLORENCIA

CONTENT

EN

Flexible Pop-Up wall system. Easy assemble.
 • Pop-Up 3x3: 1 unit / Pop-Up 3x2: 2 units.
 • Accessories corners: 3 units.
 • Spotlights: 2 units. • Trolley Cases: 2 units.

FR

Pop-Up magnétique facile à monter.
 • Pop-Up 3x3: 1 unité. / Pop-Up 3x2: 2 unités.
 • Foyer d'éclairage: 2 unités.
 • Accessoires pour les angles: 3 unités.
 • Valise de transport: 2 unités.

PT

Pop-Up magnético de fácil montagem.
 • Pop-Up 3x3: 1 unidad / Pop-Up 3x2: 2 unidades.
 • Focos: 2 unid. • Acessórios das esquinas: 3 unidades.
 • Mala de transporte: 2 unidades.

ES

Sistema de Pop-Up flexible y de fácil montaje.
 • Pop-Up de 3x3: 1 unidad / Pop-Up 3x2: 2 unidades.
 • 2 focos. • Accesorios para esquinas: 3 unidades.
 • 2 Maletas tipo Trolley.

2 spotlights are included

2 trolley cases included



WALL DETAILS



INFORMATION

Florencia is a flexible 3-walls booth graphics system made up of a Pop-up structure to create an impressive triple spaced trade show booth. With a top height of 2340mm, this event fixture features enough space for setting up counters, chairs or any display and create 2 conference environments for your business. Ideal for meeting one-on-one with potential customers at a trade show. Composed by a straight 3x3 frame, two 3x2 straight frames, 3 corner accessories and 2 spotlights. The portable display breaks down quickly, fitting neatly into the 2 portable carrying bags (included) to transport back to your business or to the next event. The 2 trolley cases are made of heavy-duty molded plastic and features roller wheels, dual handles, and locking security.

EXTERNAL SIZE & ARTWORK

*mm

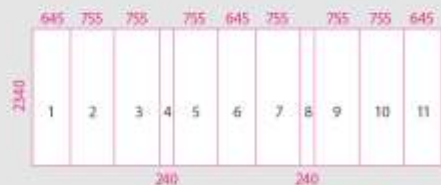
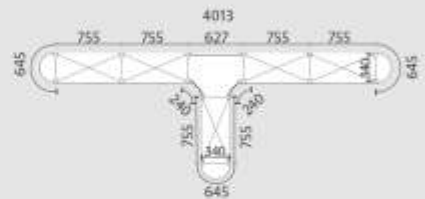

TOTAL GRAPHIC

FLORENCIA	QTY	N.W	G.W	E.B.M	SIZE
Packing	1	83kg	85.5kg	0.33	T30x430x1000mm
				0.33	T30x430x1000mm
10.644					

*Printing is available but not included

FLOOR SYSTEM DETAILS



EXTERNAL SIZE

*mm

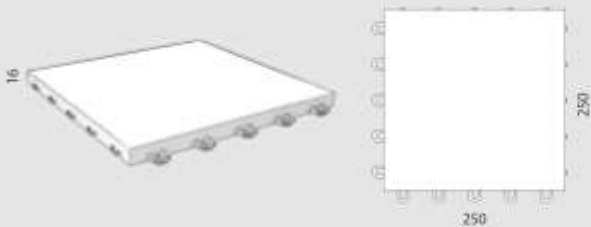

INFORMATION

Snap together these plastic interlocking floor tiles for an easy install and quick setup. Flooring made of high impact material results in long term use and dependability. Beneath each of the floor tiles there are ribbed support pillars for impact and shock absorption. Whether the 250x250mm configuration is used in a trade show booth exhibit, these multi-purpose floor tiles are suitable for indoor or outdoor events. Each unit with the reinforced composition provides a strong foundation efficient for impact and shock absorption. Ideal for a trade show booth set up. 5 colors available.

15.209



x16  (1m²)

TILE FOR FLOOR SYSTEM



FLOOR SYTEM DETAILS

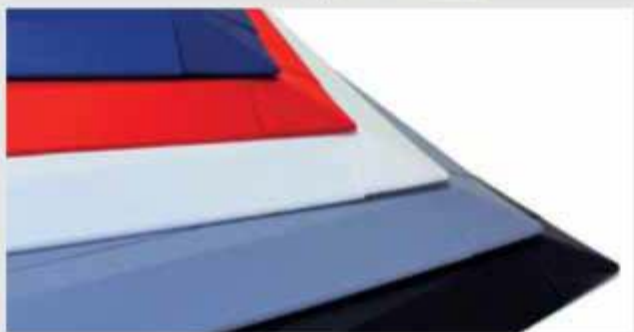
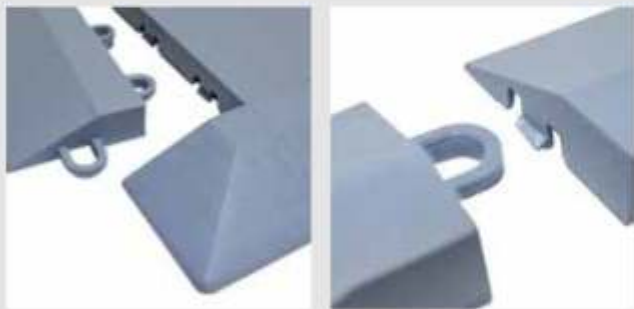

FLOOR SYTEM DETAILS



EXTERNAL SIZES

*mm

Flooring construction is made easy with the clip and loop plastic tiles which allow each component to snap together without any tool. Create a finished and clean look by adding the sloped edge and mitered corner attachments to the perimeter for a smooth transition into a trade show booth. Each unit with the reinforced composition provides a strong foundation efficient for impact and shock absorption. Ideal for a trade show booth set up. 5 colors available.



15.210		Corner x4
15.211		Frame Male x8
15.212		Frame Female x8

FRAME FOR FLOOR SYSTEM

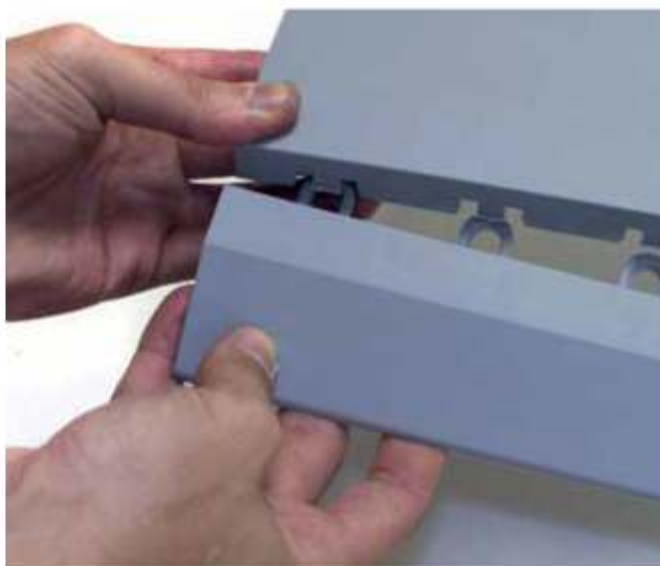

QUICK SYSTEM



TELESCOPIC POLE

aluminium pole system



1200 POLE		1500 POLE		2000 POLE	
*mm		*mm		*mm	
POLE 1		POLE 2		POLE 3	
10.961	Ø45x1200mm	10.962	Ø45x1500mm	10.963	Ø45x2000mm

7 WAYS CONNECTOR

CONNECTOR *mm

Ø40 / 45

49

7 WAYS CONNECTOR

10.968-40	Ø40mm
10.968-45	Ø45mm

ALU BLOCK

ALU BLOCK *mm

34

ALU BLOCK

10.969	x10
--------	-----

RAIL

INFORMATION *mm

- Combine it with:
 - + pvc insert
 - + end caps
 - + connecting plate
 - + side connecting block
 - + back connecting block

RAIL

10.970	Length: 2 meters
--------	------------------

POLE'S END CAPS

CAP

END CAPS

10.966	x10
--------	-----

BASE CONNECTOR

*mm

100

BASE CONN.

10.967

screw to the base

SQUARE BASE

SQUARE BASE *mm

380

SQUARE B.

10.964	380x380
--------	---------

FEET BASE

FEET BASE *mm

275

355

380

FEET BASE

10.965	
--------	--

PVC INSERT

INFO *mm

- Stick it to the PVC Adhesive



PVC INSERT

10.862

Length: 2 meter

SIDE CONNECTING BLOCK

BLOCK *mm

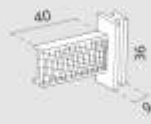

10.863

x10

BACK CONNECTING BLOCK

INFO *mm

- Rail connection.



BACK CB

10.864

x10

END CAP

INFO *mm

- Connect it to a rail.
- Grey color finished.



END CAP

10.971

x10

GRAPHIC CLIP

CLIP *mm



G.C.P.

10.539

Ø45mm

x10

10.540

Ø40mm

x10

WIRE CLIP

INFO *mm

- Wires holder.



WIRE CLIP

10.541

Ø45mm

x10

10.542

Ø40mm

x10

INFO *mm

- 19mm width.
- Front connection.



C.PLATE III

10.972

x10

100x19mm



CONNECTING PLATE

INFO *mm

- 12mm width.
- Sideway connection.



C.PLATE II

10.973

x10

100x12mm



PLASTIC CLIP

INFO

- Plastic.
- Ideal for holding poster or banner.



PLASTIC CLIP

10.537

x10 

SIDE CLIP

INFO

- Plastic.



SIDE CLIP

10.538

x10 

ARC SHELF

INFO

- Includes 2 Alu Block.

+2 Alu block included



10.969



10.959

828x350mm

SHELF

INFO

- Includes 4 Alu Block.

+4 Alu block included



10.969



10.960

825x400mm

LCD BRACKET

INFO

- Plastic.
- Includes 1 Alu Block.

+1 Alu block included

10.969



10.543



PANEL

INFO

- Metallic.
- Perforated.
- Includes 4 Alu Block.

+4 Alu block included



10.969



10.958

825x1000mm

All brochures holders include Alu Block



10.969

INFO

- Includes 1 Alu Block.
- For A4 size documents.



BROCH. A4

10.544

A4

INFO

- Includes 1 Alu Block.
- For A5 size documents.



BROCH. A5

10.545

A5

ACRILIC BROCHURE HOLDER

INFO

- Includes 1 Alu Block.
- For A6 size documents.



BROCH. A6

10.546

A6



INFO

- With connecting base. Ideal for illuminating your exhibit booth and shed light on your products.



SPOTLIGHT

10.389

475x138mm

SPOTLIGHT



PROFILE STAND 100mm

INFORMATION

Aluminum profile for the assembly of exhibition stands.
Profile dimensions: 100x100mm.

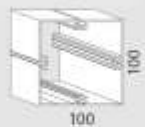

*mm

15.116 100mm

PROFILE STAND 40mm

INFORMATION

Aluminum profile for the assembly of exhibition stands.
Profile dimensions: 40x40mm.



*mm

15.118 40mm

ALUMINIUM CONNECTOR FOR PROFILE 100mm

INFORMATION

- 1. Place the connector.
- 2. Adjust the connector into the aluminium profile.

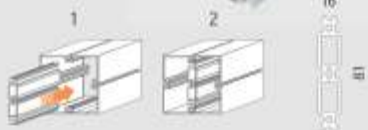

*mm

15.117 Connector 100mm

LOCK

INFORMATION

Use 1 lock for 40mm profile and 2 locks for 100mm profile.



*mm

LOCK 2 Lock for 100mm 1 Lock for 40mm

15.119 x2

PLASTIC PIECES FOR TENSION GRAPHICS

INFORMATION

Use these tension plastic fasteners with springs for attaching your canvas to the profile stand system.



*mm

15.723 x 10

PROFILE STAND



INFORMATION

- EN Holding system for glass or acrylic performing stand. Suitable for being used with 100mm aluminium profile. Material: Steel.
- FR Système de fixation modulable pour vitres ou acryliques permettant le montage de stands. S'utilise avec un profil stand de 100mm.
- PT Sistema de fixação de vidros ou acrílicos para a montagem de stands. Utiliza-se com um perfil de 100mm. Material: Aço.
- ES Sistema de fijación de cristales o acrílicos para la realización de stand. Se utiliza con el profile stand de 100mm. Material: Acero.

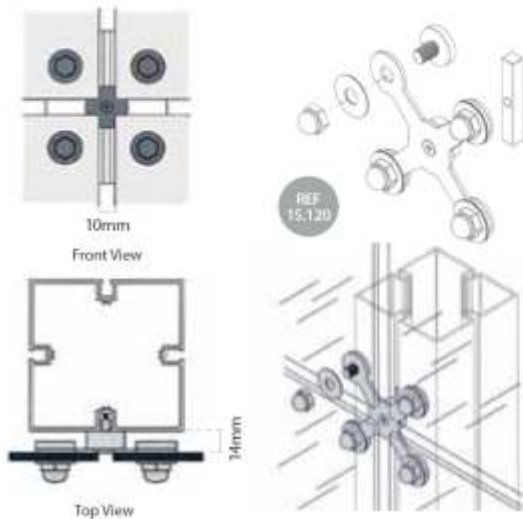

GLASS WALL



INFORMATION

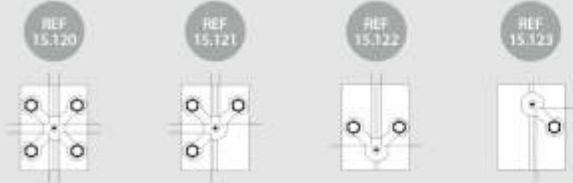

HOLES TEMPLATE

*mm

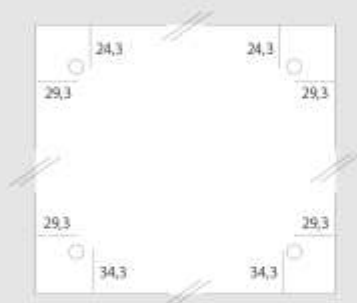

Dimensions for holes on glass or acrylic. / Dimensions pour le cristal ou l'acrylique. / Medidas para furos em vidro ou acrílico. / Medidas para agujeros en cristal o acrílico.

GLASS WALL	PARTS
15.120	4 Parts
15.121	3 Parts
15.122	2 Parts
15.123	1 Part



TRUSS DETAILS



light weight
and high
strength



ALUMINIUM
TRUSS "DUO"



STANDARD SIZES

*mm

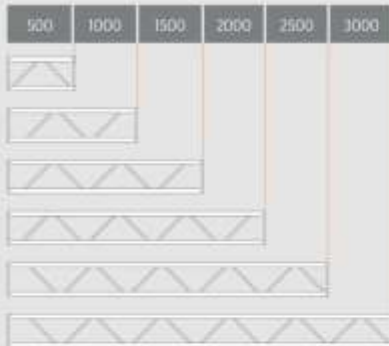

INFORMATION

Aluminium Truss "Duo" formed by 2 aluminum bars, color "natural silver."

TRUSS DUO	SIZE
15.305	500mm
15.060	1000mm
15.063	1500mm
15.066	2000mm
15.306	2500mm
15.307	3000mm



STANDARD SIZES

*mm

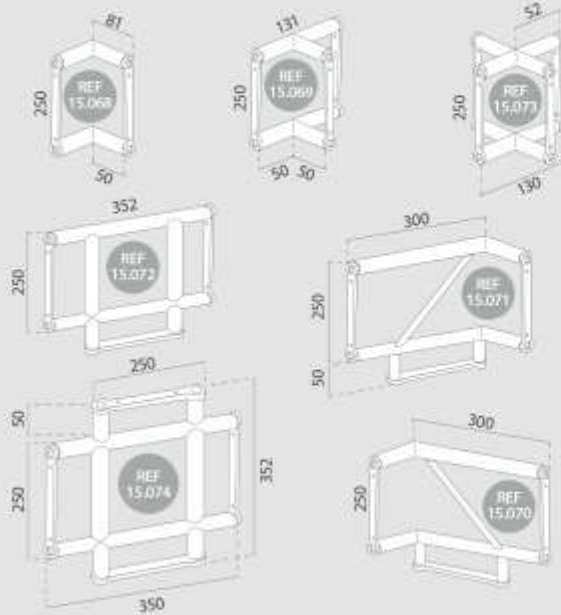

STANDARD SIZES

CONNECTOR	SIZE		
15.068	2 connection sides		
15.069	3 connection sides		
15.070	3 connection sides		
15.071	3 connection sides		
15.072	3 connection sides		
15.073	4 connection sides		
15.074	4 connection sides		

ALUMINIUM TRUSS "DUO" CONNECTOR

TRUSS DETAILS



light weight
and highly
resistant



INSTALL EXPLANATION

*mm

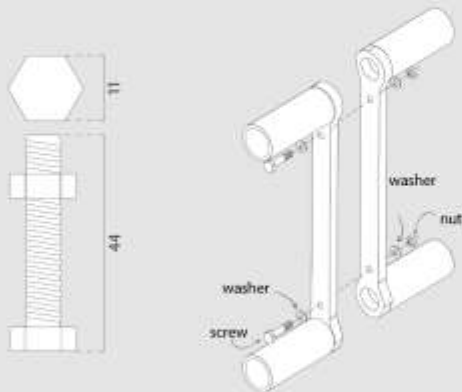

INFORMATION

These screws for mounting the aluminium Truss are made of steel. Nut is supplied.

SCREWS	SIZE
15.040	44x11mm

STEEL SCREWS FOR ALUMINIUM TRUSS





INFORMATION

EN	Vertical aluminium Truss, 32 mm diameter, Ideal for producing and assembling a booth, venues, outdoor events, placing graphics, etc. It is characterized by its great resistance, lightweight and easy assembly. Color: natural silver.
FR	Colonne de Truss fabriquée en aluminium, couleur "argent naturel" avec tubes de 32mm de diamètre. Idéal pour la réalisation et le montage de stands, scènes, événements extérieurs, suspension de bâches, etc. Léger, résistant et facile à monter.
PT	Colunas Truss fabricadas em alumínio, em cor prateada, com tubos de 32mm de diâmetro. Ideal para a realização e montagem de stands, cenários, eventos ao ar livre, colocação de lonas, entre outros. Caracteriza-se pela sua grande resistência, leveza e fácil montagem.
ES	Largueros Truss, fabricados en aluminio, color "plata natural", con tubos de 32mm de diámetro. Ideal para realización y montaje de stands, escenarios, eventos al aire libre, colocación de lonas, etc. De gran resistencia, peso ligero y fácil montaje.

ALUMINIUM TRUSS "SHOW"

light weight and resistant



with accessories

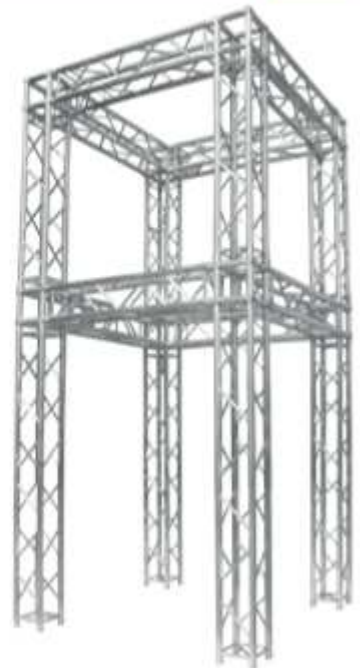

"SHOW"	SIZE	500	750	1000	1500	2000	2500	3000
15.301	500x250mm							
15.302	750x250mm							
15.141	1000x250mm							
15.143	1500x250mm							
15.145	2000x250mm							
15.303	2500x250mm							
15.304	3000x250mm							

MAIN TUBES	Ø32x1.2mm
BRACES	Ø12x1.0mm
MATERIAL	Alloy En-Aw 6005 T6
WEIGHT	1.84 kg/m



INFORMATION

EN	Connectors for joining Truss spars. Produced in aluminum and with "natural silver" finish.
FR	Cube pour l'union de colonnes de Truss, fabriqué en aluminium est de couleur "argent naturel".
PT	Cubos de união para colunas Truss fabricados em alumínio de cor prateada.
ES	Cubos para unión de largueros de Truss. Fabricados en aluminio con acabado "plata natural".



CONNECTOR	SIZE
15.147	250x250x250mm

CONNECTOR TRUSS



CONICAL CONNECTOR



INFO

Conical connector for joining Truss bars.

15.148

HALF CONICAL CONNECTOR



INFO

Conical semiconnector for joining Truss bars + bolt.

15.151

PIN



INFO

Pin for the connection of Truss bars

15.149

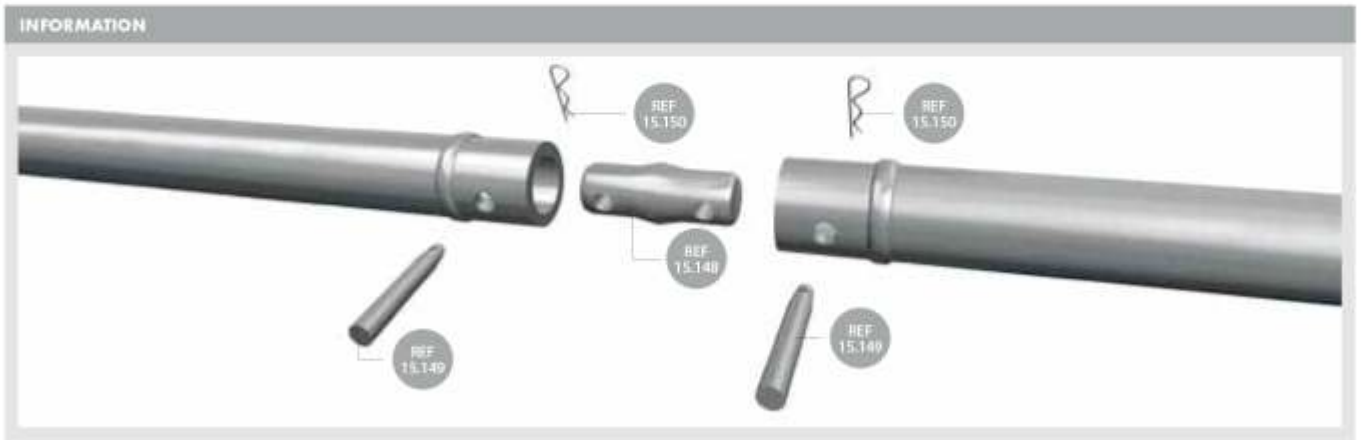

SAFETY CLIP



INFO

Clip to secure the connection of Truss bars

15.150

BASE FOR ALUMINIUM TRUSS "SHOW"



INFO

Steel base for aluminium Truss "Show".

15.300 300x300mm

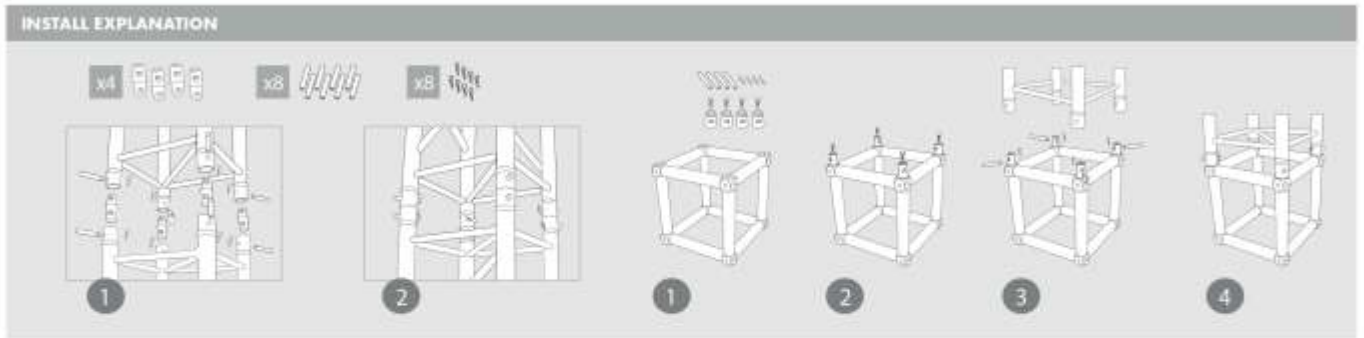

CAMIN



STOOL DETAILS



INFORMATION

The Camin Bar Stool features a adjustable 850mm max height and it is made of Polypropylene plastic, with chromed finished structure. 2 colors available.

CAMIN	QTY	N.W	G.W	C.B.M	SIZE
Packing	1	10.1kg	11.07kg	0.052	460x300x420mm
31.284	<input type="checkbox"/>	380x850x380mm			640-850mm
	<input type="checkbox"/>				

MONET



STOOL DETAILS



INFORMATION

The Monet Bar Stool features a pressure lever for an optimal height adjustment. With seat made of ABS plastic and chromed finished structure.

MONET	QTY	N.W	G.W	C.B.M	SIZE
Packing	2	15.6kg	14.8kg	0.088	420x430x515mm
31.033	<input checked="" type="checkbox"/>	350x940x420mm			730-940mm

STOOL DETAILS



INFORMATION

The Tiepolo Bar Stool features a pressure lever for getting an optimal height adjustment. With seat made of ABS plastic and chromed finished structure.

TIEPOLO	QTY	N.W	G.W	C.B.M	SIZE
Packing	2	13.9kg	14.3kg	0.170	570x490x610mm
31.043	<input type="checkbox"/>				750-960mm
31.044	<input checked="" type="checkbox"/>	470x960x470mm			
31.045	<input checked="" type="checkbox"/>				

TIEPOLO



CHAIR DETAILS



MISTRAL



CHAIR DETAILS



INFORMATION

The Mistral Chair features a 800mm height with a seat made of Polypropylene plastic with a chromed finished four-legged structure. 2 colors available.

MISTRAL	QTY	N.W	G.W	C.B.M	SIZE
Packing	1	15.6kg	18.2kg	0.123	570x570x470mm
31.281	<input type="checkbox"/>	575x800x525mm			800mm
	<input type="checkbox"/>				

BORGES



CHAIR DETAILS



INFORMATION

The Borges Chair features a 765mm height with a back and seat made of Polypropylene. And it has a four-legged beech frame. 2 colors available.

BORGES	QTY	N.W	G.W	C.B.M	SIZE
Packing	1	4.1kg	5.2kg	0.1238	780x560x770mm
31.280	<input type="checkbox"/>	420x765x480mm			765mm
	<input type="checkbox"/>				

MARTI



STOOL DETAILS



INFORMATION

The Marti Stool features a 865mm height with a seat made of Polypropylene plastic with a chromed finished four-legged structure. 2 colors available.

MARTI	QTY	N.W	G.W	C.B.M	SIZE
Packing	1	22.5kg	23.6kg	0.23	570x460x850mm
31.283	<input type="checkbox"/>	410x865x400mm			865mm
	<input type="checkbox"/>				

DELMAR



STOOL DETAILS



INFORMATION

The Delmar Stool features a 865mm height with a seat made of Polypropylene plastic. And it has a four-legged wooden structure. 2 colors available.

DELMAR	QTY	N.W	G.W	C.B.M	SIZE
Packing	1	4.6kg	5.9kg	0.064	780x460x200mm
31.282	<input type="checkbox"/>	390x865x440mm			865mm
	<input type="checkbox"/>				

TABLE DETAILS



INFORMATION

The Rubens Bar Table features a Ø600mm top surface made of ABS plastic with a stable chromed finished structure. With 2 colors available.

RUBENS	QTY	N.W	G.W	C.B.M	SIZE
Packing	1	7.3kg	8.1kg	0.06	620x200x620mm 180x180x990mm
31.037	<input type="checkbox"/>	Ø600x1090mm			
31.038	<input type="checkbox"/>				

RUBENS



TABLE DETAILS



TABLE DETAILS



INFORMATION

The Frost Bar Table features a Ø600mm top surface made of ABS plastic with a stable chromed finished structure. With 2 colors available.

FROST	QTY	N.W	G.W	C.B.M	SIZE
Packing	1	8.5kg	7.8kg	0.077	620x200x620mm
31.286	<input type="checkbox"/>	Ø600x735mm			
	<input type="checkbox"/>				

FROST



TABLE DETAILS



BANNER DETAILS



DIMENSIONS AND KIT CONTENT

*mm

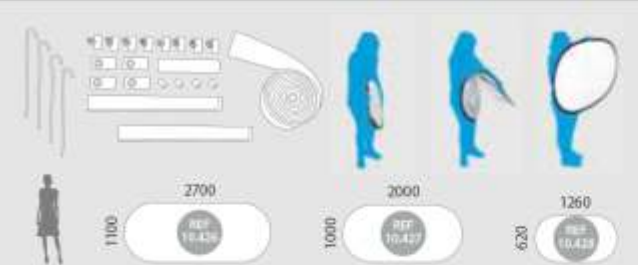

INFORMATION

This outdoor foldable banner is extremely portable and lightweight. Its flexible fiberglass providing greater stability. Carry bag, hooks, pole connectors and 60mm width fabric trape are included. Ideal for making your message stand out from the crowd at any event either indoors or outdoor.

SILVES ID	QTY	N.W	G.W	C.B.M	SIZE
Packing	5	7kg	7.25kg	0.08	660x180x660mm
Unit	1	1.40kg	1.45kg	0.012	640x30x640mm
10.428		Graphic Size: 620x1260mm			
SILVES 1000	QTY	N.W	G.W	C.B.M	SIZE
Packing	5	8.50kg	8.9kg	0.17	960x180x960mm
Unit	1	0.90kg	1kg	0.045	960x10x960mm
10.427		Graphic Size: 1000x2000mm			
SILVES 1100	QTY	N.W	G.W	C.B.M	SIZE
Packing	5	12.50kg	13kg	0.26	1200x180x1200mm
Unit	1	2.50kg	2.60kg	0.05	1140x30x1140mm
10.426		Graphic Size: 1100x2700mm			

SILVES
GOLF BANNER



*Printing is available but not included.

YUSTE

4.5m

BANNER DETAIL



ARTWORK

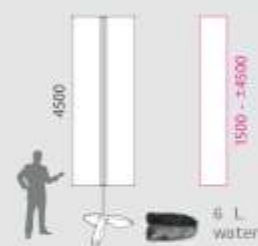

INFORMATION

Yuste is a telescopic flagpole with a refillable 6L base. It can be used with 2 flag banners (1-sided or 2-sided option). It is made of aluminium and plastic. Carry bag is included.



BREST

4.1m

BANNER DETAIL

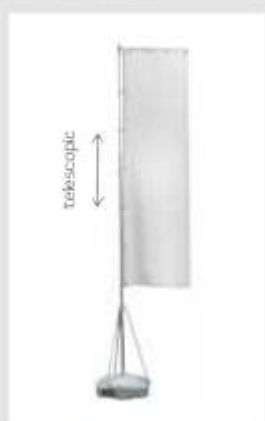

ARTWORK

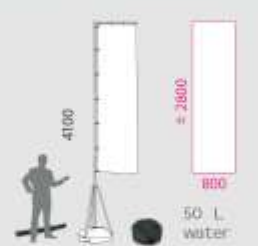

INFORMATION

Brest is a telescopic flagpole with a refillable 50L base. Its feet structure is foldable for an improved storing. It is made of aluminium and plastic. Carry bag is included.



YUSTE	QTY	NW	GW	C.B.M	SIZE
Pole	1	1.3kg	1.8kg	0.015	120x80x1690mm
Base	1	0.9kg	1.5kg	0.017	260x200x340mm
10.709		Graphic Size: ± 600x1500-4500mm (x2)			

BREST	QTY	NW	GW	C.B.M	SIZE
Pole	1	4.3kg	5.7kg	0.029	795x315x1100mm
Base	1	6kg	6.3kg	0.117	665x285x665mm
10.652		Graphic Size: ± 800x2800mm			

*Printing is available but not included

BANNER DETAILS



DIMENSIONS

ARTWORK ^{mm}

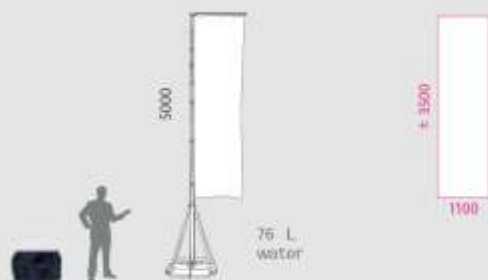

INFORMATION

The Bejar is a telescopic flagpole with a refillable 76l plastic base. Its feet structure is foldable and its base is 4-pieces removable for an improved storing. Best flagpole is made of aluminium and plastic parts. A carry nylon bag is included for a better transportation, ideal for being used at outdoor events, tradeshows: exposition entrances for displaying to large distances.

BEJAR	QTY	NW	GW	C.B.M	SIZE
Pole	1	15kg	90kg	0.04	1100x3500x100mm
Base	1	10kg	11kg	0.14	430x380x850mm
10.031		Graphic Size: 1100x3500mm			

BEJAR

5m



* Printing is available but not checked.

BANNER DETAILS

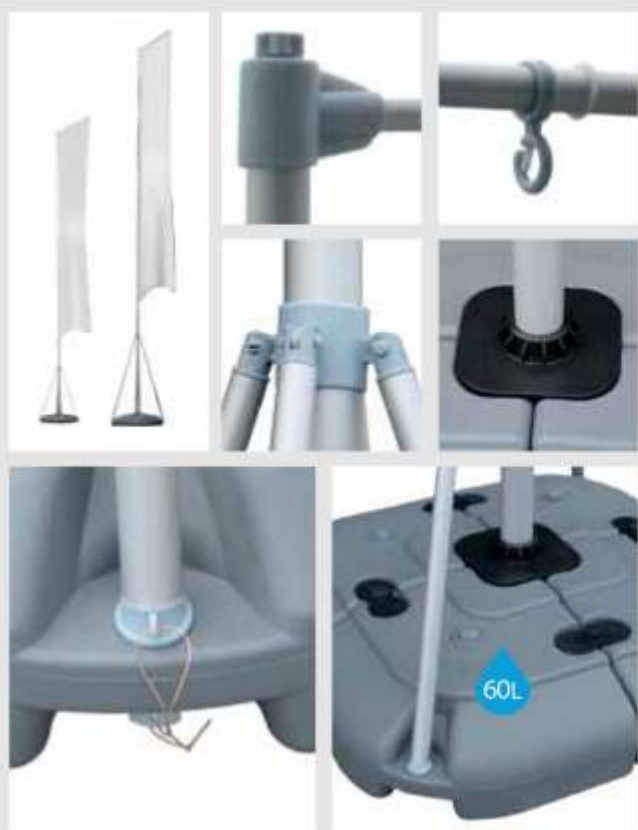

DIMENSIONS

ARTWORK

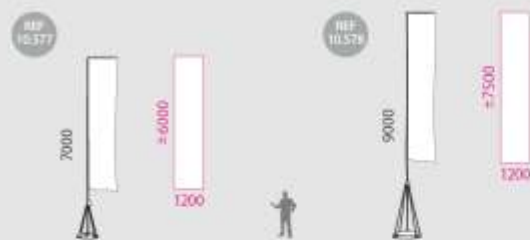

INFORMATION

The Bejar is a telescopic flagpole with a refillable 60 l plastic base. Its feet structure is foldable and its base is 4-pieces removable for an improved storing. Bejar flagpole is made of aluminium and plastic parts. A carry nylon bag is included for a better transportation. With the biggest heights available, they are ideal for being used at outdoor events, tradeshow exposition entrances.

CERGY 6000	QTY	N.W	G.W	C.B.M	SIZE
Pole	1	6.5kg	7.5kg	0.03	180x130x1700mm
Base	1	8kg	9kg	0.13	410x410x805mm
10.577	Graphic Size: ± 1200x6000mm				

CERGY 7000	QTY	N.W	G.W	C.B.M	SIZE
Pole	1	8.5kg	9.5kg	0.05	180x170x1700mm
Base	1	14kg	15kg	0.24	510x510x820mm
10.578	Graphic Size: ± 1200x7500mm				

CERGY

9-7m



*Printing is available but not included

BANNER DETAILS

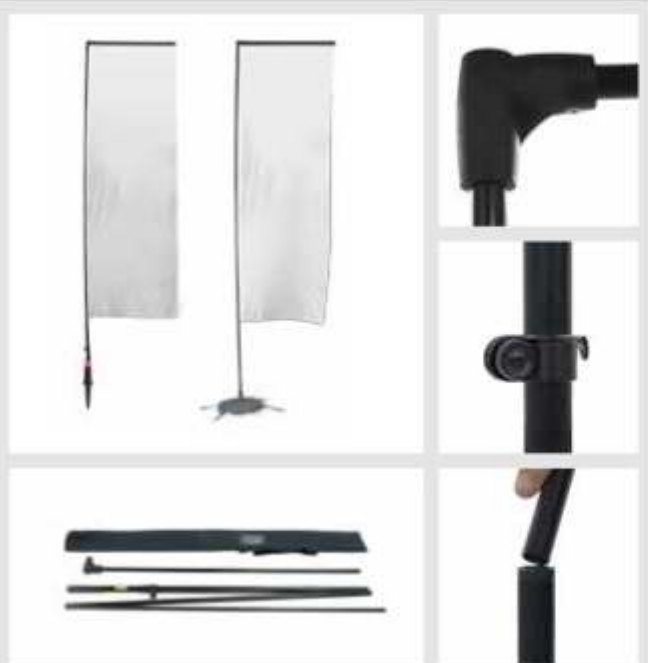

ARTWORK

*mm

SAFE ZONE
TOTAL GRAPHIC

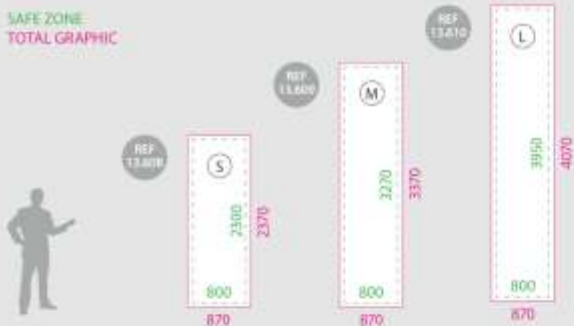

INFORMATION

ACCESSORIES AVAILABLE

Square flagpole is usually used for promoting on beaches. Its lightweight pole set-up and down in seconds for an improved storage. Carry bag included. Several accessories available later at this chapter. Textile manufacturing available (not included). You can choose black or white colour of pole sheath.

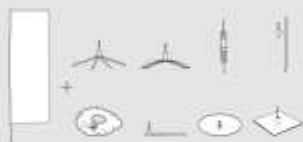

SQUARE S	QTY	N.W	G.W	C.B.M	SIZE
Packing	1	0,94kg	1,44kg	0,004	80x50x1050mm
13.608				(S)	
SQUARE M	QTY	N.W	G.W	C.B.M	SIZE
Packing	1	1,44kg	1,90kg	0,005	100x50x1050mm
13.609				(M)	
SQUARE L	QTY	N.W	G.W	C.B.M	SIZE
Packing	1	1,80kg	2,30kg	0,005	100x50x1050mm
13.610				(L)	

SQUARE



* Printing, taxes and accessories are available but not included. The photo includes only the flagpole.

BANNER DETAILS



ARTWORK

*mm

SAFE ZONE
TOTAL GRAPHIC

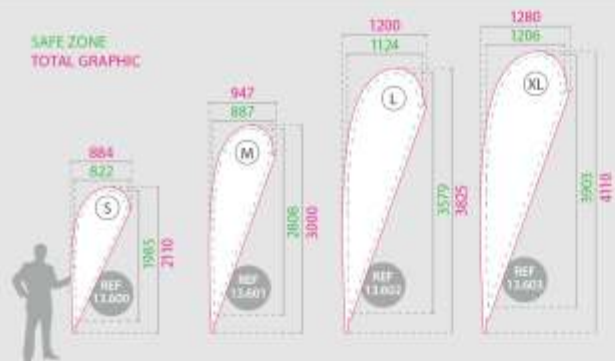

INFORMATION

The Spoon is a flagpole made of fiberglass, aluminium and plastic. The pole is collapsible for an easy portability. Also, a carry nylon bag is included. Multiple accessories are available later at this chapter. Textile manufacturing available (not included). You can choose black or white colour of pole sheath.

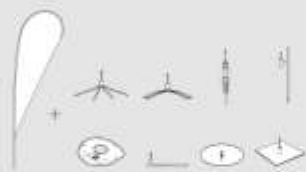

ACCESSORIES AVAILABLE

SPoons	Qty	N.W	G.W	C.E.M	Size
Packing	1	0,67kg	0,73kg	0,004	66x60x140mm
13.600				(S)	
SPoon M	Qty	N.W	G.W	C.E.M	Size
Packing	1	1,07kg	1,57kg	0,005	80x60x140mm
13.601				(M)	
SPoon L	Qty	N.W	G.W	C.E.M	Size
Packing	1	1,49kg	1,99kg	0,006	80x60x140mm
13.602				(L)	
SPoon XL	Qty	N.W	G.W	C.E.M	Size
Packing	1	1,79kg	2,29kg	0,006	80x60x140mm
13.603				(XL)	

SPOON



* Fixing, bases and accessories are available but not included. The price includes only the flagpole.

BANNER DETAILS



ARTWORK

*mm

SAFEZONE
TOTAL GRAPHIC

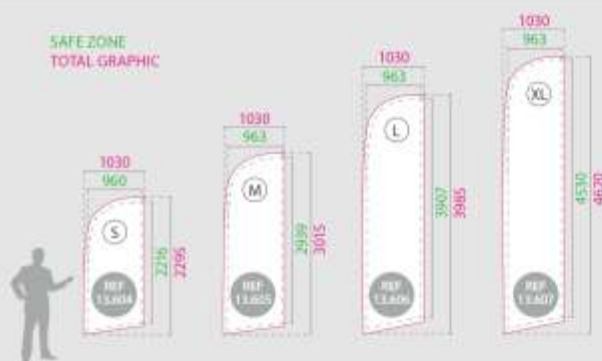

INFORMATION

ACCESSORIES AVAILABLE

The Knife is a flagpole made of fiberglass, aluminium and plastic. The pole is collapsible for an easy portability. Also, a carry nylon bag is included. Multiple accessories are available later at this chapter. Textile manufacturing available (not included). You can choose black or white colour of pole sheath.

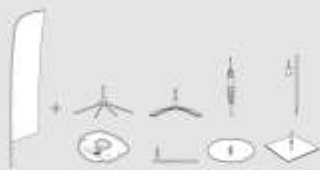

KNIFE S	QTY	N.W	G.W	C.E.M	SIZE
Packing	1	0,94kg	1,44kg	0,005	80x50x40mm
13.604				(S)	

KNIFE M	QTY	N.W	G.W	C.E.M	SIZE
Packing	1	1,15kg	1,65kg	0,005	80x50x40mm
13.605				(M)	

KNIFE L	QTY	N.W	G.W	C.E.M	SIZE
Packing	1	1,50kg	2,10kg	0,005	80x50x40mm
13.606				(L)	

KNIFE XL	QTY	N.W	G.W	C.E.M	SIZE
Packing	1	1,69kg	2,39kg	0,005	80x50x40mm
13.607				(XL)	

KNIFE



* Pricing, bases and accessories are available but not included. The price includes only the flagpole.

OUTDOOR EVENTS Flag Banner Accessories



CROSS BASE WITH WATER PLASTIC BAG

3 L bag included



CROSS BASE	QTY	N.W	G.W	C.B.M	SIZE
Packing	40	28kg	31kg	0.75	620x460x720mm
Unit	1	0.7kg	0.77kg	0.025	350x100x360mm
13.611					

INFORMATION

*mm



- With 3l refillable bag.
- Ideal for using with the larger flags, also can be used on uneven ground (even on slopes).

TIRE BASE U STYLE



TIRE BASE	QTY	N.W	G.W	C.B.M	SIZE
Packing	20	14kg	17kg	0.38	540x100x40mm
Unit	1	1.7kg	1.85kg	0.028	380x120x620mm
13.614					

INFORMATION

*mm

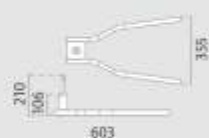

- Fast to assemble.
- Ideal for installation under car wheel thanks its U shape.

WATER PLASTIC BAG



3 L water

W.P.BAG	QTY	N.W	G.W	C.B.M	SIZE
Packing	20	3kg	4kg	0.008	300x150x100mm
Unit	1	0.5kg	0.2kg	0.009	140x40x60mm
10.766					

INFORMATION



- Great stability.
- Fast to assemble.
- Add an extra 3l weight.
- Suitable for Cross-Plate, Round and Square bases.

ROUND PLATE BASE



ROUND	QTY	N.W	G.W	C.B.M	SIZE
Packing	1	8kg	8.5kg	0.014	530x45x90mm
13.615					

INFORMATION

*mm



- Great stability.
- Fast to assemble.
- Recommended for an outdoor or indoor use with all Flying Banners.

GROUND DRILL



DRILL	QTY	N.W	G.W	C.B.M	SIZE
Packing	20	15kg	15kg	0.75	400x110x610mm
Unit	1	0.6kg	0.75kg	0.025	390x100x590mm
13.612					

INFORMATION

*mm



- Fast to assemble.
- For soft grounds, sand or snow. Ideal for displaying at the beach in summer or ski slopes in winter.

SQUARE PLATE BASE



SQUARE	QTY	N.W	G.W	C.B.M	SIZE
Packing	1	6kg	6.5kg	0.014	530x45x90mm
13.616					

INFORMATION

*mm



- Great stability.
- Fast to assemble.
- Recommended for an outdoor or indoor use with all Flying Banners.

ROUND STRAIGHT SPIKE

ideal for grass or soft grounds



SPIKE	QTY	N.W	G.W	C.B.M	SIZE
Packing	20	30kg	33kg	0.061	300x25x110mm
Unit	1	1.5kg	1.65kg	0.009	35x40x990mm
13.613					

INFORMATION

*mm



- Fast assembly.
- By the own nature of the ground spike being driven pushed into the grass or other soft grounds, providing a very stable platform.

CROSS PLATE BASE



CROSS	QTY	N.W	G.W	C.B.M	SIZE
Packing	5	21.5kg	24kg	0.030	120x60x800mm
Unit	1	4.3kg	4.8kg	0.005	110x60x160mm
13.617					

INFORMATION

*mm



- Great stability.
- Fast to assemble.
- Ideal for concrete surfaces, footpaths or also, for indoor use.

BACKPACK DETAILS



BACKPACK BANNER



INFORMATION

DIMENSIONS *mm

Comfortable backpack banner for street marketing. 3 banner holding systems available. Featuring fiberglass structure, side and top pockets, shoulder/waist buckles; soft padded for back and telescopic poles or flag tensor depending on model.

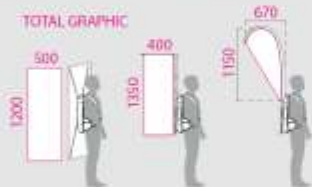

BANNER	QTY	N.W	G.W	C.B.M	SIZE
Packing	1	11kg	129kg	0.03	650x100x400mm
10.760	Graphic Size: 500x1200mm				
FLAG BANNER	QTY	N.W	G.W	C.B.M	SIZE
Packing	1	11kg	129kg	0.03	650x100x400mm
10.794	Graphic Size: 400x1350mm				
REAR DROP BANNER	QTY	N.W	G.W	C.B.M	SIZE
Packing	1	12kg	138kg	0.01	650x100x400mm
10.795	Graphic Size: 670x1150mm				

STANDARD FLAG FINISHES FASTENING FLAG SEWING

BASIC SEWING

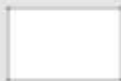

No fastening



Material: Made of Polyester 117g. Flag with basic sewing without fastening.

1



Material: Made of polyester 117g. Includes three-sided perimeter folding and reinforcement on one side. With two "D" rings for fastening.

2



Material: Made of Polyester 117g. Includes three-sided perimeter folding and reinforcement on one side. With two plastic carabiners for fastening.

3



Material: Made of Polyester 117g. Includes three-sided perimeter folding and reinforcement on one side. With two eyelets for fastening.

4

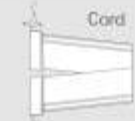

Material: Made of Polyester 117g. Includes three-sided perimeter folding and reinforcement on one side. With not elastic cord for fastening.

5



Material: Polyester 117g. Includes 3-sided perimeter folding with Ø 20mm sheath.

6



Material: Polyester 117g. Includes three-sided perimeter folding and one side reinforced. With genuine VELCRO® brand straps or cord for fastening.

7



Material: Polyester 117g. Includes three-sided perimeter folding and reinforcement on one side. With rings type "D" or carabiners for fastening.

FLAG	SIZE	BASIC SEWING	1	2	3	4	5	6	7
10.379	700x1000mm								
10.882	1500x1000mm								
10.883	2000x1200mm								
10.884	2500x1500mm								

STANDAR FLAGS SYSTEM



* VELCRO® is a registered trademark of Velcro B.V.A. | VELCRO® are una marca déposada de Velcro Indústria B.V. | VELCRO® è una marca registrata di Velcro Industrie B.V. | VELCRO® es una marca registrada de VelcroIndustria B.V.

OUTDOOR EVENTS Standard Flag System



Internationals

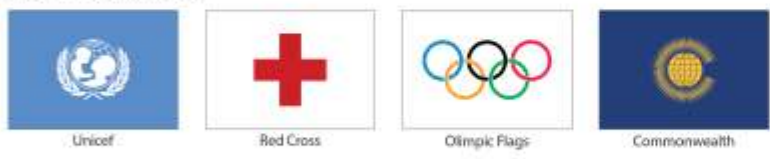

Enterprises



Universities



Sports



INFORMATION

The Wall Banner System is composed by a profile frame structure made of silver anodised lightweight aluminium and a full range of accessories for holding big size poster canvases. The wall banner system adopts a simple design to showcase your advertisement or promotional poster. Easy to assemble. The banner is attached by hanger clips through the grommets and fixed to the aluminium profile structure, allowing a simple and fast changing of the banner. Ideal for promoting your business or for displaying at outdoor exhibitions.

PROFILE FOR WALL BANNER

PROFILE DETAIL

DIMENSIONS *mm



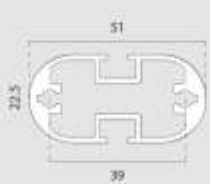

REF 13.483
REF 13.484



INFORMATION

Lightweight profile made of anodised aluminium, available in 2 or 3m length.

2m BARS	QTY	N.W	G.W	C.B.M	SIZE
Packing	2	3.90kg	4.40kg	0.018	75x75x2070mm
13.484	Length: 2000mm		x2		
3m BARS	QTY	N.W	G.W	C.B.M	SIZE
Packing	4	11.77kg	12.80kg	0.048	145x110x3070mm
13.483	Length: 3000mm		x4		

WALL BANNER SYSTEM



CORNER SUPPORT FOR WALL BANNER

SUPPORT DETAILS

INFORMATION *mm



Made of 2mm sheet metal. It includes the fixing screws.

CORNERS	QTY	N.W	G.W	C.B.M	SIZE
Packing	4	0.52kg	0.57kg	0.0021	105x105x65mm
13.485			x4		

STRAIGHT SUPPORT FOR WALL BANNER

SUPPORT DETAILS

INFORMATION *mm



Made of 2mm sheet metal. It includes the fixing screws.

STRAIGHTS	QTY	N.W	G.W	C.B.M	SIZE
Packing	4	0.41kg	0.56kg	0.0021	105x120x63mm
13.486			x4		



CORNER CONNECTION FOR WALL BANNER

CONNECTION DETAIL INFORMATION DIMENSIONS *mm



Corner Connection allows to connect aluminium profiles in the corner sections. It is made of polycarbonate. It includes the fixing screws.

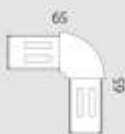

CORNER C.	QTY	N.W	G.W	C.B.M	SIZE
Packing	8	0.14kg	0.30kg	0.0021	105x100x65mm
13.487			x4		

CORNER GRIPS FOR WALL BANNER

GRIPS DETAIL INFORMATION DIMENSIONS *mm



It allows to hang the banner with corners. Easy clip-on. Made of nylon.

CORNER GRIPS	QTY	N.W	G.W	C.B.M	SIZE
16.110			x40		

CANVAS HANGERS FOR WALL BANNER

HANGER DETAIL INFORMATION DIMENSIONS *mm



This Hanger for wall banner allows to hang poster canvas and it is made of polycarbonate.



HANGERS	QTY	N.W	G.W	C.B.M	SIZE
13.334			x10		

WALL BANNER SYSTEM



PROFILE CONNECTION FOR WALL BANNER

HANGER DETAIL INFORMATION DIMENSIONS *mm



Profile Connection for the straight sections. Made of ABS plastic. With fixing screws.



PROFILE C.	QTY	N.W	G.W	C.B.M	SIZE
Packing	4	0.11kg	0.26kg	0.0021	305x120x65mm
13.488			x4		

DIMENSIONS

DIMENSIONS *mm

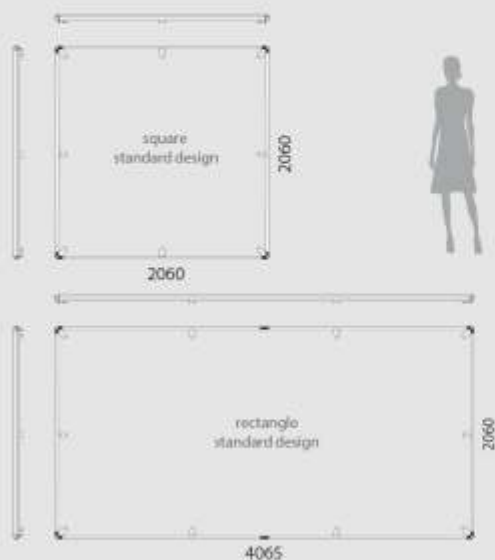

EXAMPLES STANDARD CONFIGURATION



PROFILE DETAILS



CANVAS PROFILE FOR BIG SIZES

LED

- EN Aluminium profile with or without light system suitable for indoor/outdoor assembly canvas. Specially designed for large areas.
- FR Systeme de profil approprié pour toiles géantes ou de grandes aires. Disponible avec ou sans lumière, pour l'extérieur ou l'intérieur.
- PT Sistema de perfil com iluminação para impressões de grande formato ou grandes superfícies. Adequado para interior o exterior.
- ES Sistema de perfil adecuado para lonas gigantes o grandes áreas. Disponible con o sin sistema de luz y adecuado para exterior e interior.



TEXFIX DETAILS



INFORMATION

Click system frame available with or without LED System. Each Canvas Kit contains: Aluminium profiles, hanger canvas, corner connections, Led systems, power supply. The Power supplies are always placed outside the aluminium frame of the TexFix. Ideal for giant prints destined for out-of-home campaigns. It has a simple banner attachment system for banners destined either for outdoor or indoor environments. In many different applications, and specially designed for large areas, Canvas Profile can provide the answer for a smarter, better customized banner framing solution. Canvas profile is supplied in 3 standard kit sizes. There is a full range of possibilities, each suited to specific applications. Contact us for more details and information.



PROFILE STANDARD SIZES



CANVAS PROFILE FOR BIG SIZES



CANVAS PROFILE STANDARD SIZES (INCLUDES LED)

CANVAS P/N	CANVAS SIZE
13.737	550x1300mm
13.738	1050x2540mm
13.739	1150x5040mm



HANGERS FOR CANVAS PROFILE

HANGER DETAILS

DIMENSIONS *mm



INFORMATION

This Hanger for Canvas profile is made of plastic and it is designed for holding canvas all along the profile. It is sold in 10 unit pack.

HANGER

13.334 x10 

WALL HANGERS FOR CANVAS PROFILE

HANGER DETAILS

DIMENSIONS *mm



Wall Hanger for Canvas is suitable for being used with the next profiles:

TexFix Canvas
TexFix UltraSlim
TexFix 80



WALL HANGER	QTY	N.W	G.W	C.B.M.	SIZE
Packing	4	0.21kg	0.40kg	0.0004	85x45x10mm
13.708				x4 	

*The Canvas Profile does not included the power cable connector.

WALL POLE SUPPORT STREET BANNER

SUPPORT DETAILS



KIT CONTENT



INFORMATION

*mm

Suitable for wall-mounting. Each kit consists of a Ø19mm pole, 1 metallic bracket, 1 pin with ring and mounting screws. Easy and fast banner change by removing the pin connecting the pole to the Wall-mounted bracket.



SCREW

10.202	Pole 800mm		
10.203	Pole 1000mm		

LAMP POLE CLAMPS STREET BANNER

SUPPORT DETAILS



KIT CONTENT



INFORMATION

*mm

Suitable for outdoor lamps/posts. Each kit consists of a Ø19mm pole, 1 metallic bracket, 1 pin with ring and metallic adjustable bands. Easy banner change by removing the pin connecting the pole to the bracket.

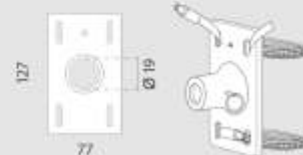

CLAMPS

10.071	Pole 800mm		
10.072	Pole 1000mm		

WALL SUPPORT STREET BANNER

SUPPORT DETAILS



INFORMATION

*mm

This Banner Support is suitable for wall-mounting. Each kit consists of 2 brackets support and mounting screws. The Wall Support is ideal for hanging big size banners from the street.

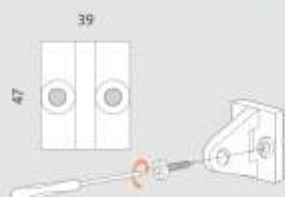

MINI SCREW

10.100	Wall-Mounted		
--------	--------------	--	--

LAMP CLAMPS STREET BANNER

SUPPORT DETAILS



INFORMATION

*mm

Suitable for outdoor lamps/posts. Each kit consists of 2 brackets support and metallic adjustable bands. The Lamp Clamps are ideal for hanging big size banners at outdoor placements.

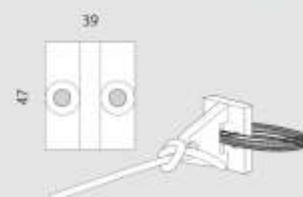

MINI CLAMPS

10.099	Hose Clamps		
--------	-------------	--	--

SUPPORT DETAILS

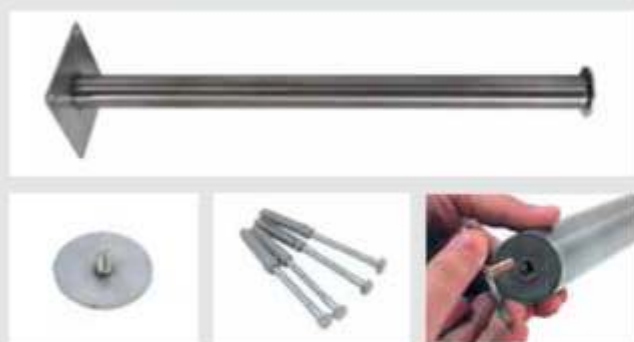

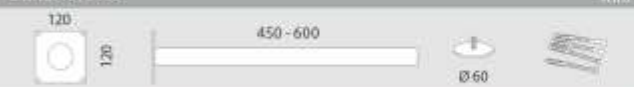

DIMENSIONS



INFORMATION

Wall Pole features a heavy gauge stainless steel pole to which the flag banner is sleeved and securely mounted to the wall. Designed for resisting strong weather conditions. With a Ø60mm cap. Easy to assemble. Wall fixing screws included.

POLE 450	QTY	N.W	G.W	C.B.M	SIZE
Packing	2	2.29kg	2.64kg	0.012	180x30x60mm
10.453	Pole Size: Ø 40x450mm		x2		

POLE 600	QTY	N.W	G.W	C.B.M	SIZE
Packing	2	2.46kg	3.00kg	0.009	180x30x70mm
10.454	Pole Size: Ø 40x600mm		x2		

WALL POLE



SUPPORT DETAILS



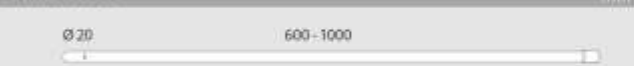

DIMENSIONS



INFORMATION

This support is designed for resisting strong wind conditions, ideal for outdoor lamps/posts from the street. Each kit consists of a Ø20mm fiberglass pole (2 length available), 1 aluminium bracket, 1 pin, 1 ring and 2 stainless steel bands.

LAMP 600	QTY	N.W	G.W	C.B.M	SIZE
Packing	1	0.6kg	1.0kg	0.009	100x60x100mm
12.454	Pole 600mm		x2		

LAMP 1000	QTY	N.W	G.W	C.B.M	SIZE
Packing	1	1.0kg	1.29kg	0.006	100x60x100mm
12.353	Pole 1000mm		x2		

LAMP SYSTEM



DISPLAY DETAILS



INFORMATION

DIMENSIONS ^{mm}

Charleroi is a 2-sided outdoor banner made of plastic, easy to install. It allows to fix 330x382mm graphics. Its base can be filled with 4l of water or sand, which adds stability to the banner. Also, it allows the barriers mounting thanks to its 2 chain connections. Lightweight for transport. It is ideal for indoor or outdoor use like shop-entrances, sidewalks gardens, restaurant terraces, etc.



QTY/BOX	QTY	N.W	G.W	C.B.M	SIZE
Packing	1	3kg	25kg	0.01	300x200x690mm
10.248	Graphic Size: 330x382mm				

CHARLEROI



DISPLAY DETAILS



INFORMATION

^{mm}

Medinaceli is a detachable stand display with a refillable 12l water plastic base which is suitable for indoor and outdoor use. The change of graphic is simple and takes only a few seconds. Includes a nylon Carry Bag for an easy transport and storing.



MEDINACELI	QTY	N.W	G.W	C.B.M	SIZE
Packing	2	7kg	18.6kg	0.11	540x890x1050mm
Un.	1	2.89kg	3.50kg	0.05	800x1000x1030mm
10.026	Graphic Size: 450x1560mm				

MEDINACELI



DISPLAY DETAILS



INFORMATION * mm

This portable and detachable display stand features a water refillable base, 6 litres capacity. Made of fiberglass, plastic and lacquered aluminium. Suitable for indoor and outdoor use, features an easy interchange of graphics. Carry bag is included.

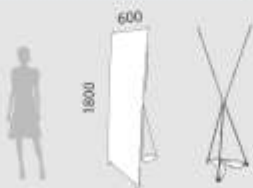

ALMAZAN	QTY	NW	GW	C.B.M	SIZE
Pole	1	0.59kg	0.8kg	0.004	80x65x150mm
Base	1	0.99kg	1kg	0.015	250x100x350mm 
10.028	Graphic Size: 600x1800mm				

ALMAZAN



DISPLAY DETAILS



INFORMATION * mm

This portable and detachable display stand features a water refillable base, 6 litres capacity. Made of fiberglass, plastic and lacquered aluminium. Suitable for indoor and outdoor use, features an adjustable height (telescopic). Carry bag is included.

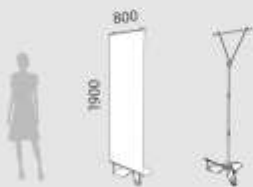

ALMENAR	QTY	NW	GW	C.B.M	SIZE
Packing	6	19kg	16.20kg	0.1	400x320x850mm
Unit	1	3.1kg	2.7kg	0.02	240x100x840mm 
10.029	Graphic Size: 800x1900mm				

ALMENAR



BASE DETAILS



BASE DETAILS



INFORMATION

*mm

With a durable design and easy portability, this double-sided base with corrugated plastic insert is ideal for placing outdoors, in areas with high-foot traffic to draw in new customers. The weighted poster holder can be filled with up to 5l of water or sand. This base is available on Grey or black color.



PANELFIX WING	QTY	N.W	G.W	C.B.M	SIZE	
Packing	1	2kg	2.55kg	0.04	440x190x520mm	 
10.442						
10.443						

PANLFX WING
OUTDOOR



* Boards are available but not included. The price includes only the base.

DISPLAY DETAILS



INFORMATION

*mm

This stand display features a 20l water refillable base. The central telescopic hub allows fast height adjustment. Kiel is ideal for indoor or outdoor use. Graphics are held with a simple and fast eyelet system. Kiel 10.574 can be used to present a double-sided graphic in areas with 2-ways traffic (after the placement of graphs, the distance to the ground on both sides can differentiate each other; ± 50 mm).

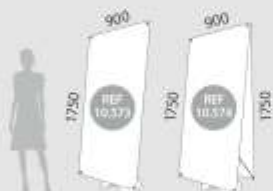

REF. SINGLE	QTY	N.W	G.W	C.E.M	SIZE
Packing	1	2.8kg	3.25kg	0.09	400x200x1080mm
10.573	Graphic Size: 900x1750mm				
REF. DOUBLE	QTY	N.W	G.W	C.E.M	SIZE
Packing	1	3kg	3.45kg	0.09	400x200x1080mm
10.574	Graphic Size: 900x1750mm x2				

KIEL



BANNER SUPPORT DETAILS



DIMENSIONS *mm

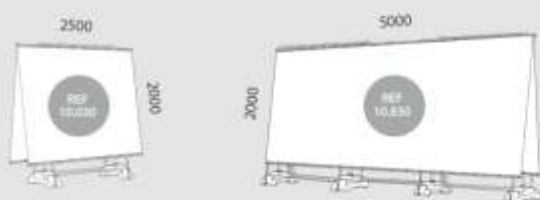

INFORMATION

The Barahona 10.030 Model features 2 Bases (fill each one with 25l water or sand) and a one or two-sided design for displaying large graphic banners so it is perfect for an outdoor use where bases can resist strong wind conditions. The Barahona 10.830 features 4 Bases (fill each one with 25l of water or sand). Its 4 ultra-large bases are very stable for an outdoor use, which ones are available to resist strong wind conditions. This Barahona model is the first choice for a huge outdoor display background (visual: 5000x2000mm).

BARAHONA1	QTY	N.W	G.W	C.B.M	SIZE
Pole	1	11.3kg	16kg	0.04	400x210x850mm
Base	1	8kg	9kg	0.11	430x300x850mm

10.030 Graphic Size: 2500x2000mm

BARAHONA1	QTY	N.W	G.W	C.B.M	SIZE
Pole	1	17.2kg	21.3kg	0.044	170x150x720mm
Base	1	13.30kg	18.3kg	0.12	470x320x850mm

10.830 Graphic Size: 5000x2000mm

BARAHONA



SIDELINE BANNER DETAILS



Printed on fabric.
Impressão em tecido.
Impresión en tela.



DIMENSIONS

ARTWORK

*mm



INFORMATION

This promotional Sideline Banner features a lightweight aluminum structure, the design of its structure allows its customization with a double-sided textile cover for printing your advertisement or your own corporate logo. Includes carrying bag and it is supplied with stakes for fixing to the ground.

MANAUS	CITY	N.W	G.W	C.B.M	SIZE
Packing	1	0kg	3.2kg	0.04	20x90x2000mm
10.791	Graphic Size: 2050x900mm				

MANAUS
SIDELINE BANNER



SIDELINE BANNER DETAILS



EXTERNAL SIZE

ARTWORK

*mm



INFORMATION

This promotional Sideline Banner is made of lightweight aluminum, the design of its structure allows its customization with a double-sided canvas for printing your advertisement or your own corporate logo. Includes carrying bag for an easy transportation and storing.

PARANA	QTY	NW	GV	C.B.M	SIZE
Packing	1	7kg	8.3kg	0.049	200x200x1220mm
10.548		Graphic Size: 2390x880mm			

PARANA
SIDELINE BANNER



SIDELINE BANNER DETAILS



DIMENSIONS

*mm



INFORMATION

This promotional barrier banner is made of lightweight plastic, features a bottom space for customizing, has reflective stripes at the top and rotating bases. Ideal for events thanks to its linkable design. Includes carrying bag for an easy transportation. 1100mm or 2000mm width available.

BARRE 1100	QTY	NW	GV	C.B.M	SIZE
Packing	1	8.94kg	9.95kg	0.086	1020x1020x50mm
80.206		External Size: 1100x1020x50mm			
BARRE 2000	QTY	NW	GV	C.B.M	SIZE
Packing	1	13kg	14kg	0.151	1020x1020x50mm
80.207		External Size: 2000x1020x50mm			

LINKABLE
SIDELINE BANNER

